



 **ELCO-E-TRADE SRL**
Via Marconi, 1
20065 INZAGO Milano - Italia
Phone +39 02 95319.1
Fax +39 02 95310138
info@elco-spa.com
www.elco-spa.com

 **REGAL DE MEXICO S. DE R.L. DE C.V.**
Jose Timoteo Rosales # 4616
Col. Niño Artillero
MONTERREY, Nuevo Leon, México 64280
Phone + 52 (81) 5000 7900
ventasmexico@regalbeloit.com
www.regalbeloit.com

 **REGAL BELOIT DE COLOMBIA**
Calle 140 N 10a - 48 Oficina 204
BOGOTÁ, Colombia
Phone +57 (1) 744-8491 / +57 (1) 744-8492
paula.ruiz@regalbeloit.com
www.regalbeloit.com

 **ELCO DO BRASIL LTDA**
Avenida Armando De Andrade, 549
06754-210 - TABOÃO DA SERRA - SP-Brasil
Phone (005511) 47019337 / 47019650 / 47878029
Fax (005511) 47873106
henrique.pinto@elcobrasil.com
www.regalbeloit.com

 **ELCO MOTORS ASIA PTE LTD**
22 Kallang Avenue #07-06
Hong Aik Industrial Building - SINGAPORE 339413
Phone +65 6298 9169
Fax +65 6291 6520
andy.lieu@elcoasia.com
elcoasia@singnet.com.sg
www.regalbeloit.com

 **ELCO CHINA LIMITED**
Xincheng Industrial Zone, Hengli
Guangdong Province, PRC
Phone +86 769 82203112
Fax +86 769 83727379
Bruce.Hochstettler@regalbeloit.com
www.regalbeloit.com

 **ELCO MOTORS LTD**
Office 502 Building 38/4, letter A, Nevsky prospect
ST PETERSBURG, Russia, 191011
Phone + 7 (812) 3349961
info@elcorussia.com
www.regalbeloit.com

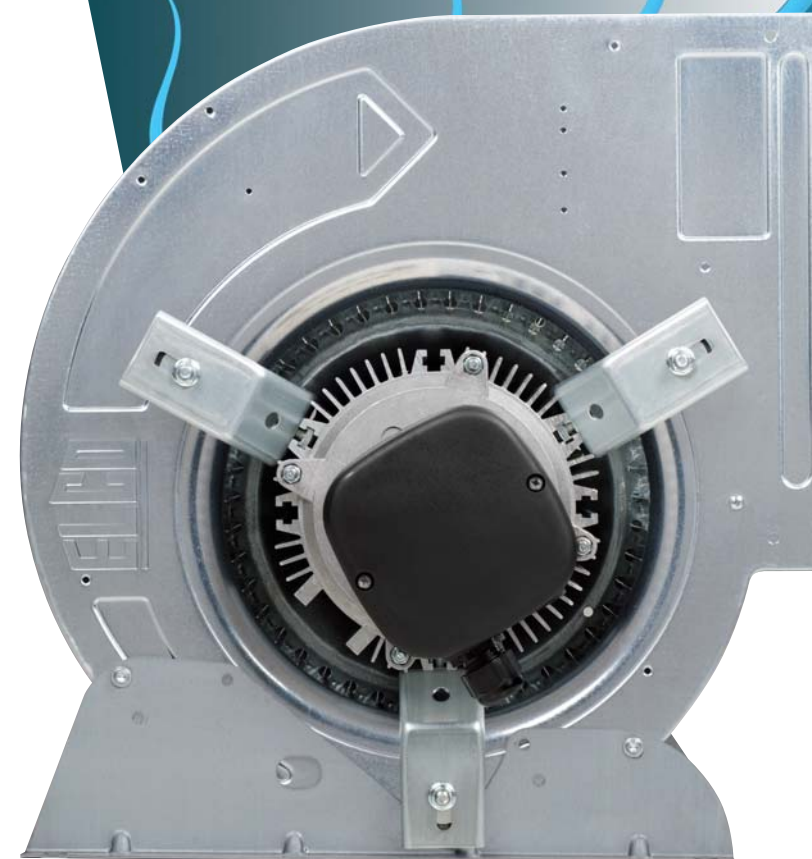

DD Centrifugal Blowers

ErP 2015

A Regal Brand

REGAL

A Regal Brand

REGAL



La Società

Il Gruppo **ELCO** è uno dei pochi produttori a livello mondiale che possa vantare un'esperienza di oltre 50 anni nella produzione di gruppi ventilanti nel campo del riscaldamento, ventilazione e condizionamento (HVAC). Questa posizione di riconosciuta leadership è il risultato di uno specifico know-how nella progettazione e produzione di motori elettrici frazionari, unito all'ottima competenza sull'aeraulica, nonché di un range di prodotti in grado di soddisfare tutte le richieste del mercato.

Il recente sviluppo internazionale del Gruppo, con unità produttive dislocate su tre continenti, è la migliore premessa per offrire le "soluzioni **ELCO**" ad un mercato non più domestico-europeo, ma ormai "globale", sia per chi ricerca soluzioni articolate (gruppi ventilanti), sia per chi si orienta sui singoli componenti elementari.



The Company

ELCO is one of the few world-wide manufacturers with more than 50 years of experience in the production of fan deck units used in the heating, ventilation and air conditioning field (HVAC). Its acknowledged leadership is the result of a specific know-how both in the design and in the manufacturing of fractional horsepower motors combined along with an excellent mastery of aeraulic techniques, as well as a range of products that satisfy all market requirements.

The recent international development of the **ELCO** Group, with its manufacturing plants located worldwide, represents the best preliminary condition to offer "**ELCO** solutions" not only to a domestic/european market but even and above all to a "global" market both in the research of integrated solutions (e.g. fan-decks) and single basic components.



La Société

Le Groupe **ELCO** est l'un des producteurs dans le monde qui peuvent vanter plus de 50 ans d'expérience dans la fabrication des ventilateurs dans les domaines du chauffage, de la ventilation et de la climatisation (HVAC). La position de leadership acquise sur le marché est le résultat de l'expertise **ELCO** dans ce secteur spécifique. La conception du produit, la fabrication des moteurs électriques, la maîtrise des problématiques aérauliques propres au marché et enfin une gamme de produits répondant à toutes les exigences des clients renforcent la leadership d'**ELCO**.

Le récent développement international du Groupe, avec l'ouverture des sites de production sur trois continents, est une condition préalable pour pouvoir offrir les «solutions **ELCO**» sur le marché "global", aussi bien pour la clientèle intéressée aux ventilateurs complets, qu'à aux leurs composants.



Das Unternehmen

Die Unternehmensgruppe **ELCO** ist einer der wenigen Hersteller weltweit, der auf eine mehr als fünfzigjährige Erfahrung in der Produktion von Lüftereinheiten im Bereich Heizung, Lüftung und Klimatechnik (HLK) zurückblicken kann. Diese anerkannte Führungsposition ist das Ergebnis eines spezifischen Know-hows bei der Entwicklung und der Herstellung von FHP-Motoren und der optimalen Kenntnis und Beherrschung der Problemstellungen der Lufttechnik sowie eines Produktangebots, das allen Anforderungen des Marktes gerecht wird.

Die in den letzten Jahren erfolgte internationale Entwicklung der Gruppe mit Produktionsstandorten auf drei Kontinenten ist die beste Voraussetzung für das Angebot der "Lösungen **ELCO**" nicht mehr nur auf dem europäischen Binnenmarkt, sondern auf dem globalen Markt. Dies gilt sowohl für komplexe Lösungen (Lüftereinheiten) als auch für einzelne grundlegende Bauteile.



La Empresa

El Grupo **ELCO**, es uno de los pocos productores a nivel mundial que cuenta con más de 50 años de experiencia en la fabricación de ventiladores para la calefacción, ventilación y acondicionamiento (HVAC). Esta posición de liderazgo no sólo es resultado de un know-how específico en el proyecto y fabricación de motores eléctricos, sino también del excelente dominio de la aeráulica, así como de un gran abanico de productos para cumplir con todas las exigencias del mercado.

El reciente desarrollo internacional del Grupo, que cuenta con plantas en tres continentes, contribuye a ofrecer "soluciones **ELCO**" a un mercado no sólo nacional/europeo sino sobre todo global, tanto para la búsqueda de soluciones complejas (grupos de ventilación) como de componentes elementales.



La Progettazione

La pluridecennale esperienza di progettazione per questi particolari ventilatori è raccolta oggi in una completa banca dati che permette di proporre ai clienti un ampio ventaglio di soluzioni tecniche per ottimizzare la scelta del ventilatore più idoneo per ogni singola applicazione.

Il team tecnico si avvale di sistemi CAD, di un moderno laboratorio per prove elettriche ed aerauliche in accordo alle norme AMCA 210-99, di una camera riverberante per le prove di potenza sonora a norme UNI EN ISO 3741:2001, di camere climatiche "fredda" e "tropicale", adatte a simulare le condizioni ambientali reali in cui si trovano ad operare i ventilatori.

La speciale sezione "Ricerca e Sviluppo" è inoltre alla costante ricerca di soluzioni innovative che spesso anticipano le richieste del mercato, come per esempio nelle problematiche di regolazione, nell'ottimizzazione dell'efficienza energetica, nella riduzione dei livelli sonori, etc.



The Design

The multi-decade experience in the design of these particular fans is stored in a complete database from where customers can choose, among a wide range of technical solutions, the most suitable for any single application.

The technical team is provided with 3D CAD, an advanced lab for electric and aeraulic tests in compliance with AMCA 210-99 rules, a reverberation chamber for sound power tests according to UNI EN ISO 3741:2001, "cold" and "tropical" chambers suitable for the simulation of the real working environmental conditions of the fans.

The "Research and Development" department is engaged in a never ending quest for innovative solutions, often ahead of market requirements, such as air volume regulation, energy efficiency improvement, noise level reduction and so on.



Le Développement

Des décennies d'expérience dans la conception de ces ventilateurs spécifiques aux besoins clientèle, fournissent à ELCO une vaste et unique base des données permettant de sélectionner pour chaque client une solution optimale à son application.

Le département technique est équipé des systèmes de projet CAD 3D, d'un laboratoire moderne pour les tests électriques, mécaniques et aérauliques conformément à la norme AMCA 210-99. Une chambre de réverbération pour les tests de puissance acoustique est utilisée en conformité avec la norme UNI EN ISO 3741:2001, des chambres climatiques "froide" et "tropicale", pour la simulation des conditions environnementales dans lesquelles les produits sont supposés travailler.

Le département "R&D" est en constamment à la recherche de solutions innovantes qui misent à anticiper les demandes du marché, avec attentions particulières concernant: l'économie d'énergie, la réduction des niveaux acoustiques, les prestations aérauliques, la régulation, etc.



Die Entwicklung

Die Erfahrungen, die über Jahrzehnte in der Entwicklung dieser speziellen Ventilatoren gesammelt wurden, befinden sich heute in einer einzigartigen und umfassenden Datenbank, mit der dem Kunden ein breiter Fächer an technischen Lösungen angeboten werden kann, um die Auswahl des geeigneten Ventilators für jede einzelne Anwendung zu optimieren.

Das technische Team verfügt über CAD-Systeme und geeignete Software für die Erstellung von 3D-Zeichnungen, ein modernes Labor für die elektrischen und lufttechnischen Tests in Übereinstimmung mit den Normen AMCA 210-99, eine Hallkammer für die Prüfungen der Schallleistung gemäß der Normen UNI EN ISO 3741:2001 sowie eine "kalte" und eine "tropische" Klimakammer für die Simulation der tatsächlichen Umgebungsbedingungen, in denen die Ventilatoren eingesetzt werden.

Der spezielle Bereich "Forschung und Entwicklung" sucht ständig nach innovativen Lösungen, die häufig die Anforderungen des Marktes vorwegnehmen, wie beispielsweise bei den Problemen der Regulierung, der Optimierung der Energieeffizienz, der Reduzierung der Geräuschemission usw.



El Proyecto

Gracias a la larga experiencia en el desarrollo de estos equipos, hoy día nuestros clientes pueden contar con un amplio conjunto de soluciones técnicas para elegir el ventilador más adecuado para cada aplicación.

El departamento técnico cuenta con sistemas CAD y software para la realización de dibujos tridimensionales, un moderno laboratorio para pruebas eléctricas y aeráulicas que cumplen con las directivas AMCA 210-99, una cámara reverberante para las pruebas de potencia sonora según UNI EN ISO 3741:2001, cámaras climáticas "fría" y "tropical" adecuadas para simular las condiciones medioambientales reales en que trabajan los ventiladores.

El departamento "Investigación y Desarrollo" siempre intenta encontrar soluciones innovadoras, como por ejemplo en los campos de la regulación, optimización de la eficiencia energética y reducción de los niveles de ruido.



La Produzione

La crescente domanda di soluzioni ELCO ha ispirato la completa riorganizzazione dei sistemi di produzione, che si avvalgono di diverse linee di assemblaggio automatiche che, esaltando un'elevata flessibilità, permettono di supportare la crescita del parco clienti.

Queste linee, armonizzate per ottenere una maggiore efficienza produttiva, sono dotate di sofisticate attrezzature e strumenti atti a garantire un prodotto finale altamente qualificabile nel rispetto delle richieste di mercato. Inoltre l'organizzazione dei processi produttivi viene svolta secondo le moderne metodologie "LEAN PRODUCTION" e "SIX SIGMA".

Apparati informatici implementati sulla linea produttiva permettono di visualizzare in tempo reale il processo produttivo e velocizzare le procedure, liberando risorse per ottenere valore aggiunto sulle attività in essere.



The Production

The increasing request of ELCO solutions led to a complete reorganization of production systems, by adopting high duty semi-automatic lines able to meet the constant growth of customers.

These production lines are equipped with sophisticated instruments apt for granting selected products, computerized devices allow to display in real time the productive process and speed up the operating procedure; furthermore, the productive process is developed according to "LEAN PRODUCTION" and "SIX SIGMA" methodologies.

IT tools in the assembly line show the production process in real time, increasing the efficiency of the process itself.



La Production

Le succès des ventes a imposé une réorganisation complète des systèmes de production qui emploient aujourd'hui plusieurs lignes automatiques, ce qui permet de produire avec flexibilité et suivant la volatilité du marché.

Ces lignes, conçues pour atteindre une plus grande productivité, sont équipées d'outils sophistiqués pour assurer un contrôle en ligne à 100% et un niveau qualitatif des plus élevés selon les exigences du marché. Les procès productifs sont conçus et mis en place en appliquant des méthodes conformes aux systèmes de contrôle «LEAN PRODUCTION» et «SIX SIGMA».

Chaque opération est surveillée par un système informatique qui permet de vérifier le processus de production en temps réel pour une efficacité maximale. Ce contrôle permet également une utilisation optimale des ressources disponibles.



Die Produktion

Die steigenden Verkaufserfolge haben zu einer vollständigen Restrukturierung der Produktionssysteme geführt, die heute auf mehreren automatischen Anlagen basieren, mit denen Produktionsvolumina gewährleistet werden können, die weit über der derzeitigen Nachfrage des Marktes liegen, ohne dass Abstriche bei der hohen Flexibilität gemacht werden müssen.

Diese Anlagen, die für eine höhere Produktivität aufeinander abgestimmt sind, sind mit modernsten Ausrüstungen und Instrumenten ausgestattet, mit denen ein hochqualifiziertes Endprodukt entsprechend der Marktanforderungen gewährleistet werden kann. Darüber hinaus erfolgt die Organisation der Produktionsprozesse mit den modernen Methoden "LEAN PRODUCTION" und "SIX SIGMA".

Auf der Produktionsanlage implementierte Computer ermöglichen die Anzeige der Produktionsprozesse in Echtzeit sowie die Beschleunigung der Arbeitsvorgänge, und setzen damit Ressourcen für einen Mehrwert der bestehenden Tätigkeiten frei.



La Producción

Los crecientes éxitos de venta han impuesto la completa reorganización de los sistemas de producción, que hoy se sirven de varias líneas automáticas que, sin sacrificar una alta flexibilidad, permiten mantener el desarrollo de nuestros clientes.

Estas líneas, armonizadas para conseguir mayor eficiencia productiva, están equipadas de sofisticados equipos que garantizan un producto final extremadamente exigente, de acuerdo a las solicitudes del mercado. Además, la organización de los proyectos de producción se lleva a cabo según las modernas metodologías "LEAN PRODUCTION" y "SIX SIGMA".

Equipos informáticos en la línea de producción permiten visualizar en tiempo real el proceso de producción y acelerar los procedimientos soltando recursos para conseguir valor añadido en las actividades vigentes.



Il Prodotto

I ventilatori centrifughi serie DD, con ventole pala avanti accoppiate direttamente al motore, sono la soluzione ideale per le applicazioni nel campo del riscaldamento, ventilazione e condizionamento dell'aria (HVAC). La vasta gamma di prodotti e l'accoppiamento a motori tipo PSC consentono di scegliere il ventilatore più idoneo alle vostre necessità.

La parte ventilante, composta da una coclea compatta in lamiera zincata, è stata appositamente progettata per fornire eccellenti prestazioni aerodinamiche, mentre la ventola pala avanti in lamiera o in materiale plastico è stata progettata per ottenere efficienze aerauliche elevate.

Il motore PSC migliorato nella sua efficienza è stato accoppiato per fornire nel complesso un range di prestazioni elevate in grado di rispettare la Direttiva Europea 327/2011.

Particolari accorgimenti nel fissaggio del motore alla coclea hanno ottenuto lo scopo di una drastica riduzione del livello di vibrazione ed un conseguente basso livello sonoro.



The Product

The DD series centrifugal blowers, with forward-curved blades directly coupled to the motor, are the perfect solution for the application in the field of heating, ventilation and air conditioning (HVAC). The wide range of products and the coupling with PSC type motors allow the choice of the most suitable fan blower for any need.

The ventilating part, composed of a compact housing made of galvanized steel plate has been specifically designed to supply excellent aerodynamic performances, whereas the forward-curved blade made of plate or plastics has been designed to reach high aeraulic efficiencies.

The PSC motor, enhanced in its efficiency, has been coupled to reach, as a whole, a range of high performances able to respect the European Directive 327/2011.

Peculiar solutions adopted for the motor fixing to the housing got the result of an effective reduction of vibration and, consequently, of noise level.



Le Produit

Les ventilateurs série DD, avec des hélices centrifuges à action, directement accouplés au moteur, sont la solution idéale pour votre application dans le domaine de la ventilation, du chauffage et de la climatisation (HVAC). La large gamme dimensionnelle des ventilateurs et le couplage avec les moteurs type PSC permettent de choisir pour chaque client une solution optimale et unique à son application.

La partie ventilant est composée d'une volute galvanisée compacte spécialement conçue pour offrir d'excellentes performances aérodynamiques, et d'une hélice centrifuge à action en tôle ou en matière plastique conçue pour obtenir des rendements aéraulique élevés.

Le moteur PSC amélioré dans son efficacité est utilisé pour fournir des hautes performances en conformité avec la Directive Européenne 327/2011.

Le fixage de la volute au moteur est étudié avec l'objectif de réduire drastiquement le niveau des vibrations et du bruit conséquent.



Das Produkt

Die Radialventilatoren der Serie DD mit vorwärts gekrümmten Schaufeln des Lüferrades, die direkt an den Motor angeschlossen werden, stellen eine ideale Lösung für Ihre Anwendungen im Bereich Heizung, Lüftung und Klimatechnik (HLK) dar. Das umfangreiche Produktangebot und die Kopplung mit PSC Motoren ermöglichen die Auswahl des für Ihre Anforderungen optimal geeigneten Ventilators.

Das Lüfterteil besteht aus einer kompakten Schnecke aus verzinktem Blech und liefert exzellente aerodynamische Leistungen, während das Lüferrad mit vorwärts gekrümmten Schaufeln aus Blech oder Kunststoff eine hohe Lüftungseffizienz gewährleistet.

Durch den angekoppelten PSC Motor, mit verbessertem Wirkungsgrad, werden hohe Leistungsbereiche gewährleistet die der europäischen Richtlinie 327/2011 genügen.

Besondere Lösungen für die Fixierung des Motors an der Schnecke führen zu einer drastischen Reduzierung der Vibrationen und damit folglich zu einem geringen Schalldruckpegel.



El Producto

Los ventiladores centrifugos de la serie DD, con hélices hacia adelante acopladas directamente al motor, constituyen la solución ideal para las aplicaciones en el campo de la calefacción, ventilación y acondicionamiento del aire (HVAC). La amplia gama de productos y el acoplamiento a motores PSC permiten elegir el ventilador más adecuado a sus necesidades.

La parte de ventilación, que se compone de coclea compacta de chapa zincada, se ha diseñado para conseguir excelentes prestaciones aerodinámicas, mientras la hélice hacia adelante de chapa o material plástico se ha realizado para lograr eficiencias aeraúlicas notables.

El motor PSC se ha mejorado en su eficiencia y está acoplado para tener elevadas prestaciones con grados de eficiencia que cumplen con la Directiva Europea 327/2011.

La fijación particular de los motores a la coclea permite reducir el nivel de vibración y por consiguiente el nivel de ruido.



Il Prodotto

Questa tipologia di motori è in grado di sviluppare elevate potenze con dimensioni contenute e soprattutto incontrare le richieste di mercato orientate al "risparmio energetico", oltre a contribuire in modo significativo ad una drastica riduzione di CO₂ immesso nell'atmosfera.

Il motore, fornito aperto o completamente chiuso in lamiera verniciata con 1 o 3 velocità, progettato per funzionare alla tensione di rete 230 V e frequenze 50/60 Hz; presenta potenze che vanno da 1/6 HP a 1 HP. I motori sono accoppiati in modo opportuno ai ventilatori nel range da 7" a 12". Questo accoppiamento consente una vasta gamma di prestazioni aerauliche che coprono le richieste più esigenti.



The Product

In spite of its small dimensions this type of motors can develop high power outputs and, above all, it meets the market request concerning the "energy saving", besides contributing to a drastic CO₂ reduction of the emissions in the atmosphere.

The motor, supplied open or completely closed in varnished steel with 1 or 3 speeds, designed to work at supply voltage of 230 V, 50/60Hz, powers from 1/6 HP to 1 HP, is properly coupled with fans in the range from 7" to 12". This coupling allows a wide range of aeraulic performances in order to meet the most challenging request.



Le Produit

Ce type de moteurs est capable de développer puissances élevées des dimensions compactes. Ils répondent aux exigences du marché en ce qui concerne "l'économie d'énergie", et ils contribuent de manière significative à une réduction drastique des émissions de CO₂.

Le moteur, complètement fermé, en acier peint, à 1 ou 3 vitesses, a été conçu pour fonctionner à une tension d'alimentation de 220 V, 50/60 Hz. Les puissances rendues par les moteurs sont entre 250 W et 750 W, et sont couplées de manière appropriés avec les ventilateurs diamètre de 7" à 12" (de 180 mm à 304 mm). Ce couplage permet une large gamme de performances aerauliques qui couvrent tous les besoins.



Das Produkt

Dieser Motortyp kann bei kompakten Maßen hohe Leistungen und eine Performance bereitstellen, die weit über denen von PSC-Motoren liegt, und entspricht damit, neben einem signifikanten Beitrag zur drastischen Reduzierung des CO₂-Ausstoßes in die Umwelt, insbesondere den Energiesparanforderungen des Marktes.

Der Motor offen oder mit vollständig geschlossenem Gehäuse aus lackiertem Blech, eins oder drei Geschwindigkeiten, ausgelegt für den Betrieb bei Netzspannung 230 V und Frequenzen 50/60 Hz, stellt Leistungen zwischen 1/6 PS und 1 PS bereit, und wird in geeigneter Weise mit den Ventilatoren im Bereich zwischen 7" und 12" gekoppelt. Diese Kopplung ermöglicht eine breite Palette von lufttechnischen Leistungen, die auch den anspruchsvollsten Anforderungen gerecht werden.



El Producto

Esta tipología de motores puede desarrollar elevadas potencias con dimensiones reducidas; además contribuyen al ahorro energético, reduciendo de forma significativa el CO₂ emitido en el medioambiente.

El motor, suministrado abierto o completamente cerrado en chapa zincada con 1 o 3 velocidades, proyectado para el funcionamiento con tensión de red 230 V y frecuencias 50/60 Hz presenta potencia que van de 1/6 HP a 1 HP. Los motores están acoplados a los ventiladores entre 7" y 12". Esto permite alcanzar varias prestaciones aeráulicas que cubren las solicitudes más exigentes.



Il Prodotto

Tutti i motori ELCO sono progettati e costruiti in ottemperanza alle Direttive di Bassa Tensione 2006/95/EC e di Compatibilità Elettromagnetica 2004/108/EC con riferimento alla EN 55014-1, EN 61000-3-2, EN 61000-3-3, così come alla Direttiva Macchine 2006/42/EC, ed in accordo con le Norme Standard CENELEC EN 60335-1, EN 60335-2-24, EN 60335-2-89, EN 60529, EN 60034-1.



La società ELCO-E-TRADE Srl si riserva di modificare anche senza preavviso le indicazioni tecniche contenute nel catalogo. L'utilizzatore è responsabile della corretta installazione dei componenti descritti nel catalogo rispettando le norme in vigore in ciascun Paese e dei limiti imposti nel presente catalogo. Le prestazioni indicate sono da considerarsi indicative e soggette a tolleranze. Il grado IP è garantito per montaggio con cavo rivolto verso il basso.



The Product

All motors are designed and manufactured in compliance with the Low Voltage 2006/95/EC and Electromagnetic Compatibility 2004/108/EC Directives with reference to EN 55014-1, EN 61000-3-2, EN 61000-3-3, as well as the Machinery Directive 2006/42/EC, and in accordance with the Standards CENELEC EN 60335-1, EN 60335-2-24, EN 60335-2-89, EN 60529, EN 60034-1.

ELCO-E-TRADE Srl reserves itself the right to modify also without prior notice all indicated technical information. The user is responsible for the correct installation of components listed in the catalogue in compliance with existing regulations of each Country and the restrictions imposed. Performances in this catalogue are for reference only. IP rating granted with supplying cable facing down.



Le Produit

Tous les moteurs ELCO sont conçus et produits en conformité aux Directives Basse Tension 2006/95/EC et Compatibilité Electromagnétique 2004/108/EC en référence aux EN 55014-1, EN 61000-3-2, EN 61000-3-3, et aux Directives 2006/42/EC CENELEC EN 60335-1, EN 60335-2-24, EN 60335-2-89, EN 60529, EN 60034-1.

ELCO-E-TRADE Srl se réserve le droit de modifier sans préavis les spécifications techniques indiquées dans le catalogue. L'utilisateur est responsable pour la correcte utilisation et installation des produits décrits dans le catalogue en conformité avec les normes en vigueur dans chaque pays. Les performances indiquées sont à titre uniquement indicatif et sous réserve des tolérances. Le degré de protection est garanti pour un montage avec la sortie câble vers le bas.



Das Produkt

Alle Motoren ELCO werden in Übereinstimmung mit der Niederspannungsrichtlinie 2006/95/EG, der Richtlinie zur elektromagnetischen Verträglichkeit 2004/108/EG mit Bezug auf die Normen EN 55014-1, EN 61000-3-2 und EN 61000-3-3, und der Maschinenrichtlinie 2006/42/EG, sowie den Standardnormen CENELEC EN 60335-1, EN 60335-2-24, EN 60335-2-89, EN 60529 und EN 60034-1 entwickelt und hergestellt.

Das Unternehmen ELCO-E-TRADE Srl behält sich das Recht vor, die im vorliegenden Katalog angegebenen technischen Daten jederzeit auch ohne Vorankündigung zu ändern. Der Benutzer ist für die korrekte Installation der im Katalog beschriebenen Produkte unter Einhaltung der geltenden Bestimmungen im jeweiligen Land verantwortlich. Die Leistungen sind annähernd und der Toleranz unterworfen. Schutzart IP ist für die Montage mit Kabel nach unten gewährleistet.



El Producto

Todos los motores ELCO se han proyectado y construido según las Directivas de Baja Tensión 2006/95/EC y de Compatibilidad Electromagnética 2004/108/EC con referencia a EN 55014-1, EN 61000-3-2, EN 61000-3-3, a la Directivas Máquinas 2006/42/EC y a las normas estándar CENELEC EN 60335-1, EN 60335-2-24, EN 60335-2-89, EN 60529, EN 60034-1.

La empresa ELCO-E-TRADE Srl tiene el derecho de modificar sin aviso previo las indicaciones técnicas en este catálogo. El usuario es responsable de la correcta instalación de los componentes indicados en el catálogo, cumpliendo con las normas vigentes de cada País y las limitaciones indicadas. Las prestaciones indicadas deben considerarse indicativas y sujetas a tolerancias. El grado IP se asegura con cable montado hacia abajo.

CENTRIFUGAL BLOWERS DD

Overall Dimensions without accessories

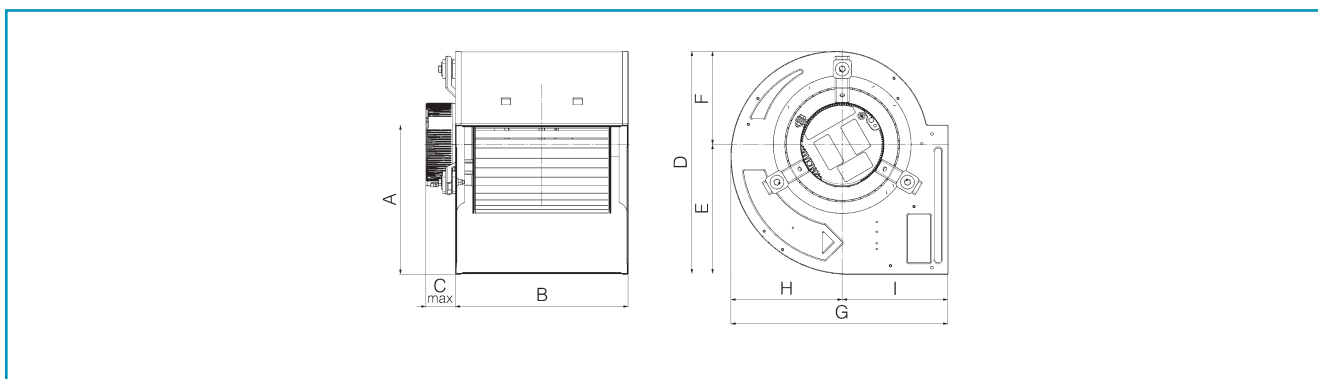

Model	A	B	D	E	F	G	H	I
7/7	216	230	327	187	140	301	164.5	136.5
7/9	216	285	327	187	140	301	164.5	136.5
9/7	260	233	388	226	162	378	194	184
9/9	260	301	388	226	162	378	194	184
10/8	289.6	265	443	249.5	193.5	424.5	221.5	203
10/10	289.6	331	443	249.5	193.5	424.5	221.5	203
12/9	342	309	521	294.5	226.5	490.5	260.5	230
12/12	342	395	521	294.5	226.5	490.5	260.5	230

Overall Dimensions with fixing flange

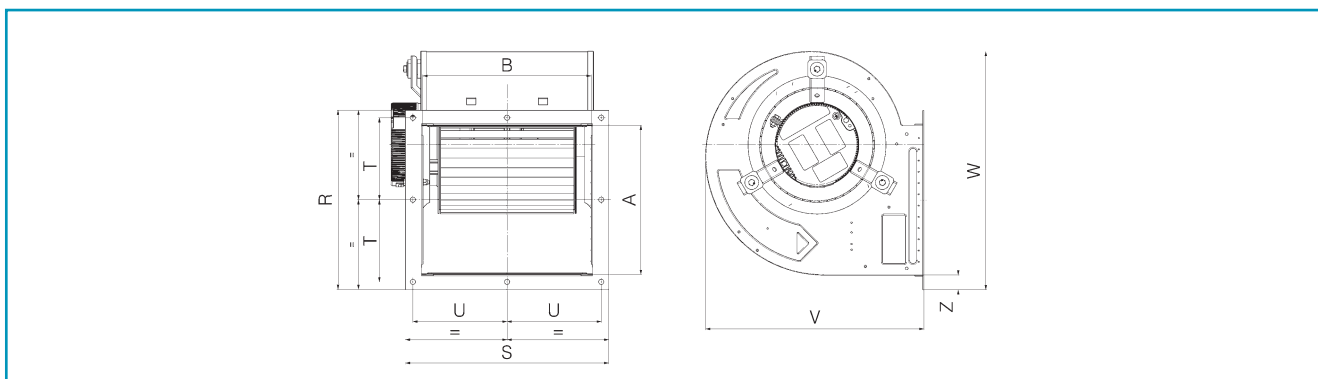

Model	R	S	T	U	V	W	Z
7/7	262	292	100/116	135/131	303	350	23
7/9	262	347	100	162.5	303	350	23
9/7	311	288	142.5	131	380	413.5	25.5
9/9	311	354	142.5	164	380	413.5	25.5
10/8	340	321	157	147.5	427.5	427.5	25.5
10/10	340	387	157	180.5	427.5	427.5	25.5
12/9	390	365	182	169.5	493.5	545.5	24.5
12/12	390	451	182	212.5	493.5	545.5	24.5

CENTRIFUGAL BLOWERS DD

Overall Dimensions with support feet

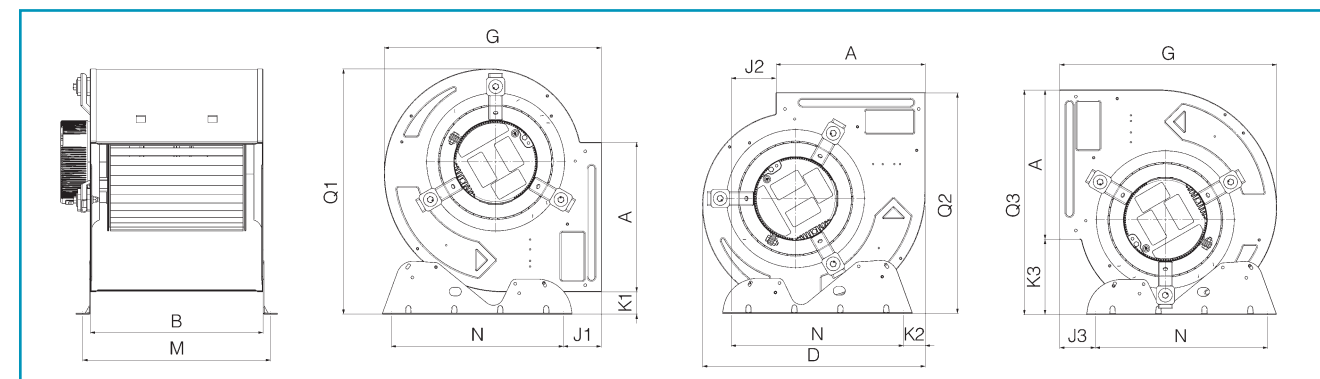

Model	A	B	G	J1	J2	J3	K1	K2	K3	M	N	Q1	Q2	Q3
7/7	216	230	301	19.5	57	48.5	14	48	115	263	225	341	303.5	331
7/9	216	285	301	19.5	57	48.5	14	48	115	318	225	341	303.5	331
9/7	260	233	378	66	78	62	39	38	131	259	300	427	386	391
9/9	260	301	378	66	78	62	39	38	131	327	300	427	386	391
10/8	289.6	265	424.5	67	92	68	38	42	158	291	340	481	430	448
10/10	289.6	331	424.5	67	92	68	38	42	158	357	340	481	430	448
12/9	342	309	490.5	69	106	69	38	40	185	335	408	559	496	527
12/12	342	395	490.5	69	106	69	38	40	185	421	408	559	496	527



CHARTS BLOWER'S SELECTION 6 POLES

ErP 2015

N.	Model	W	Poles	Speed	Power Supply	Air Flow m ³ /h Max - Min	Pressure mmH ₂ O Max	Test	Web.	ErP	Grade Eff. (G)
1	DD 7/7	60	6	1	1 ~	1150 - 1150	13	PDD_5132	387	Free	-
2	DD 7/7	145	6	3	1 ~	1350 - 1000	16	PDD_903	56	Free	-
3	DD 9/7	245	6	3	1 ~	2700 - 1700	23	PDD_5051	487	2015	44.1
4	DD 9/9	245	6	3	1 ~	3000 - 1700	27	PDD_5049	382	2015	44.0
5	DD 10/8	245	6	3	1 ~	3000 - 1800	30	PDD_5062	488	2015	44.7
6	DD 10/8	550	6	3	1 ~	3700 - 2850	31	PDD_5082	341	2015	49.5
7	DD 10/10	245	6	3	1 ~	3200 - 1950	33	PDD_5058	383	2015	44.1
8	DD 10/10	550	6	3	1 ~	4250 - 2600	33	PDD_5067	388	2015	44.2
9	DD 12/9	550	6	3	1 ~	4000 - 2350	49	PDD_5072	489	2015	49.7
10	DD 12/9	735	6	3	1 ~	4700 - 2950	47	PDD_5015	490	2015	48.9
11	DD 12/9	1100	6	1	3 ~	5500 - 5500	48	PDD_5013	491	2015	46.7
12	DD 12/12	550	6	3	1 ~	4500 - 2700	47	PDD_5071	480	2015	44.5
13	DD 12/12	735	6	3	1 ~	5200 - 3200	46	PDD_5006	386	2015	48.4
14	DD 12/12	1100	6	1	3 ~	7500 - 7500	48	PDD_5004	385	2015	45.4

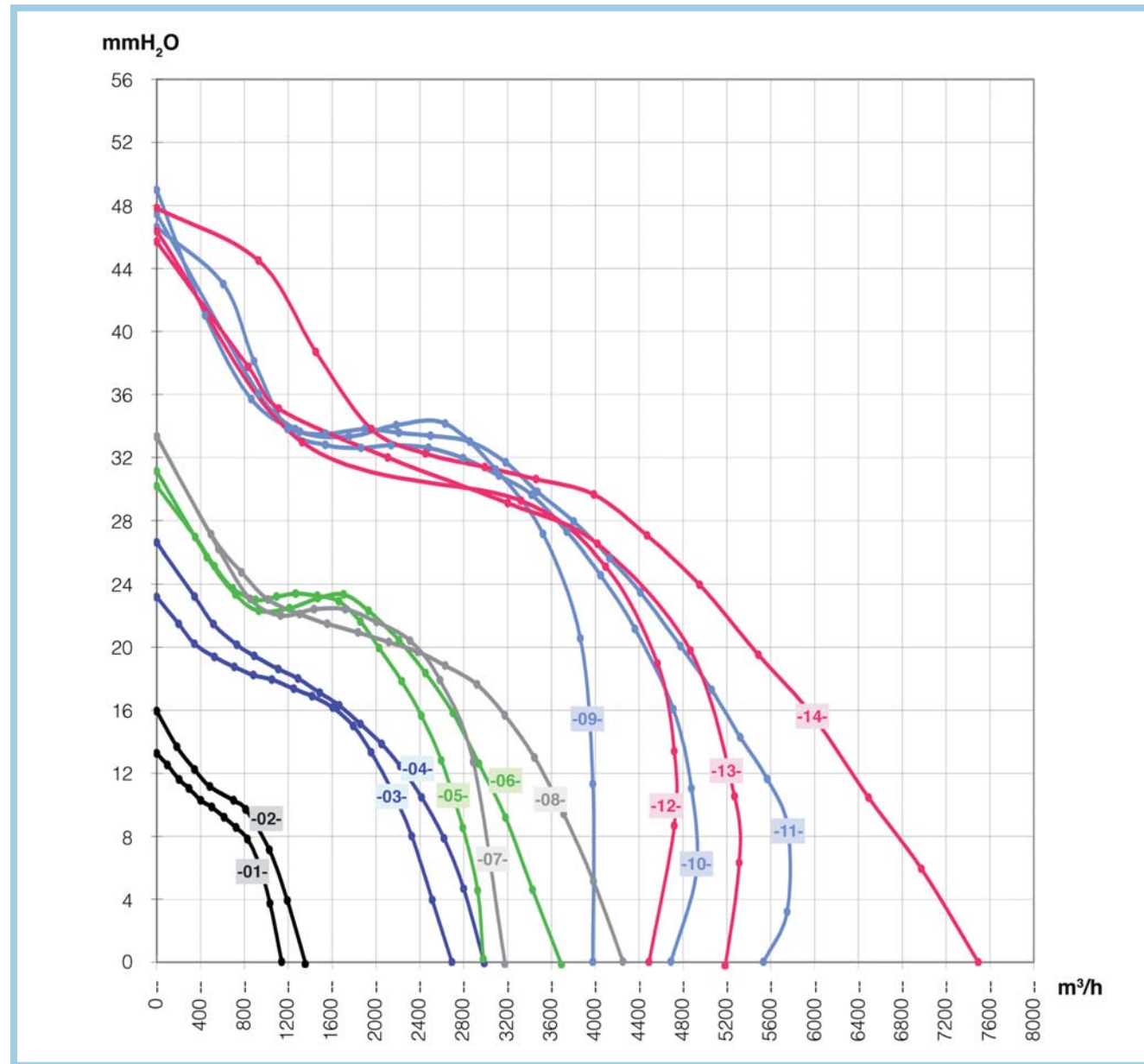

CHARTS BLOWER'S SELECTION 4 POLES

ErP 2015

N.	Model	W	Poles	Speed	Power Supply	Air Flow m ³ /h Max - Min	Pressure mmH ₂ O Max	Test	Web.	ErP	Grade Eff. (G)
1	DD 7/7	145	4	3	1 ~	1900 - 1100	40	PDD_5044	346	2015	44.1
2	DD 9/9 T	300	4	3	1 ~	2200 - 1350	45	PDD_5031	347	2015	44.0
3	DD 9/7	370	4	3	1 ~	2700 - 1400	50	PDD_5056	354	2015	44.1
4	DD 9/9	370	4	3	1 ~	2800 - 1500	58	PDD_5030	348	2015	44.4
5	DD 9/9	550	4	3	1 ~	2850 - 1600	58	PDD_5046	349	2015	44.0
6	DD 10/8	370	4	3	1 ~	2400 - 1350	65	PDD_5032	350	2015	48.0
7	DD 10/8	550	4	3	1 ~	3200 - 2050	69	PDD_5037	359	2015	50.7
8	DD 10/10	370	4	3	1 ~	2700 - 1500	65	PDD_5033	380	2015	44.0
9	DD 10/10	550	4	3	1 ~	3500 - 2200	74	PDD_5041	326	2015	44.1

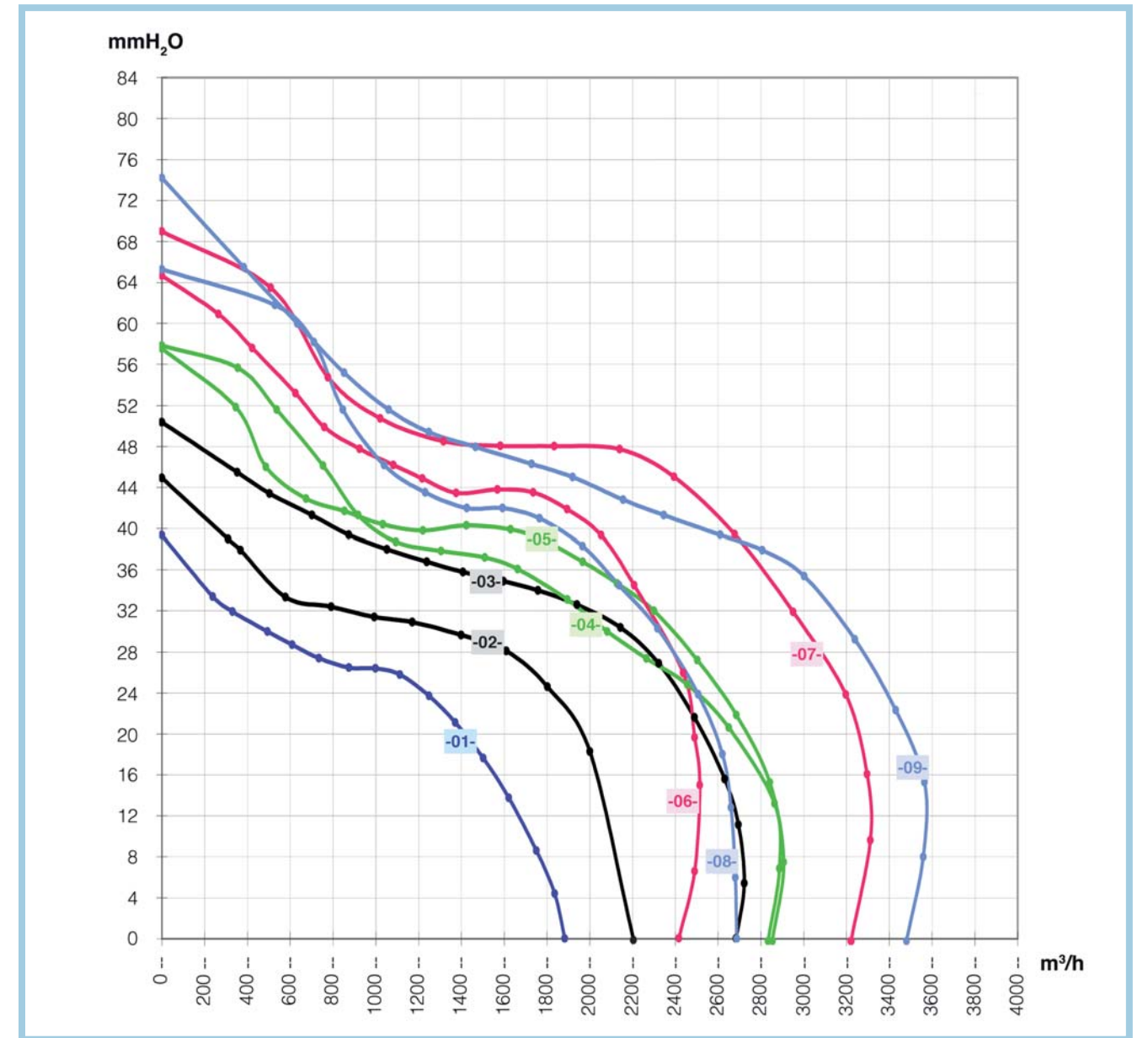



PERFORMANCE CURVES

DD 7/7 - 60-6P-1V 6 Poles

ErP Free

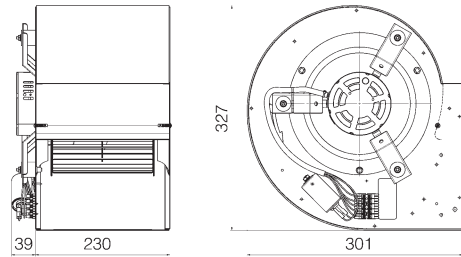

Ventilator Type: DD 7/7
 Blowers Material: Metal
 Housing Material: Metal
 Motor Support Material: Metal

Motor Type: 3 RGM
 Power Supply: 1 ~
 Nominal Voltage: 230V
 Frequency: 50-60 Hz
 Nominal Watts: 60
 Range Power: 200-254 V
 Capacitor: 3.15 µF

Electrical Insulation Class: Cl.F (155°C)
 Protection: Thermally Prot.

Test: PDD-5132 Web: 387

Operating limits Max Speed 50 Hz (Rating Values)
 Win: Max 145 (W)
 Ampere: Max 0.65 (A)
 Static Pressure: Min 0 - Max 12 (mmH₂O)

Measurement Category - A -
Free Inlet - Free Outlet

Value @ max. efficiency (50 Hz)
 Air Flow: 827 (m³/h)
 Static Pressure: 7.8 (mmH₂O)
 Rpm: 876 (min⁻¹)
 Power Input: **122 (W)**

Overall efficiency (η): 14.4
Grade efficiency (G): 26.5

dB(A)_LW (Sound Level Power @ Free Air)

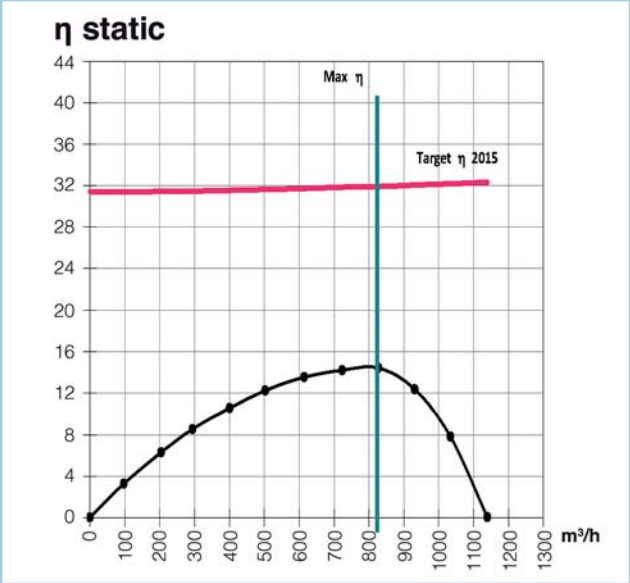
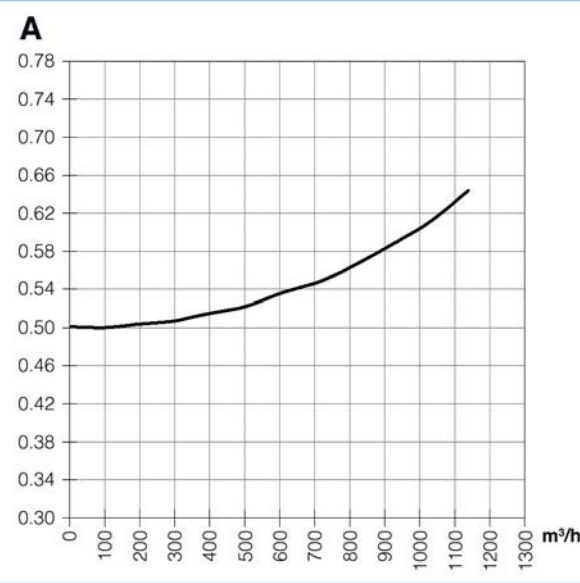
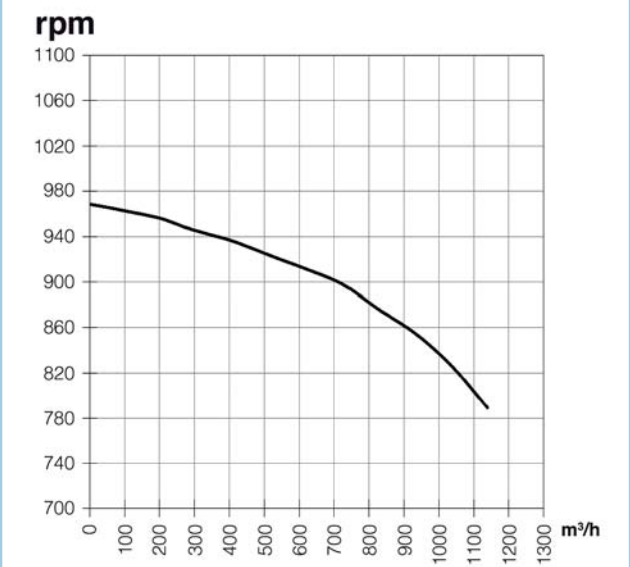
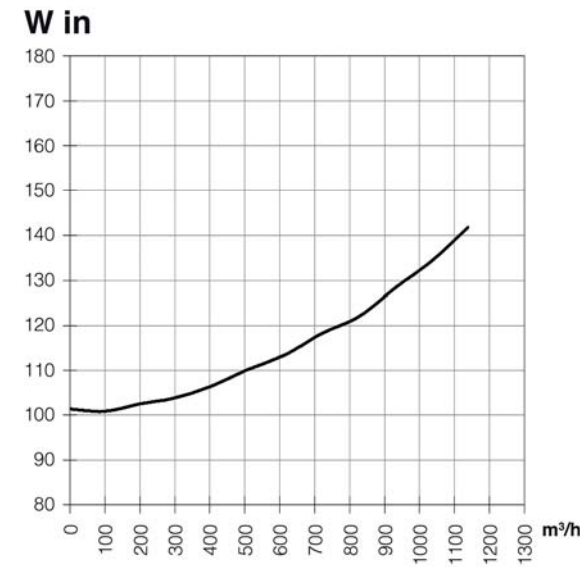
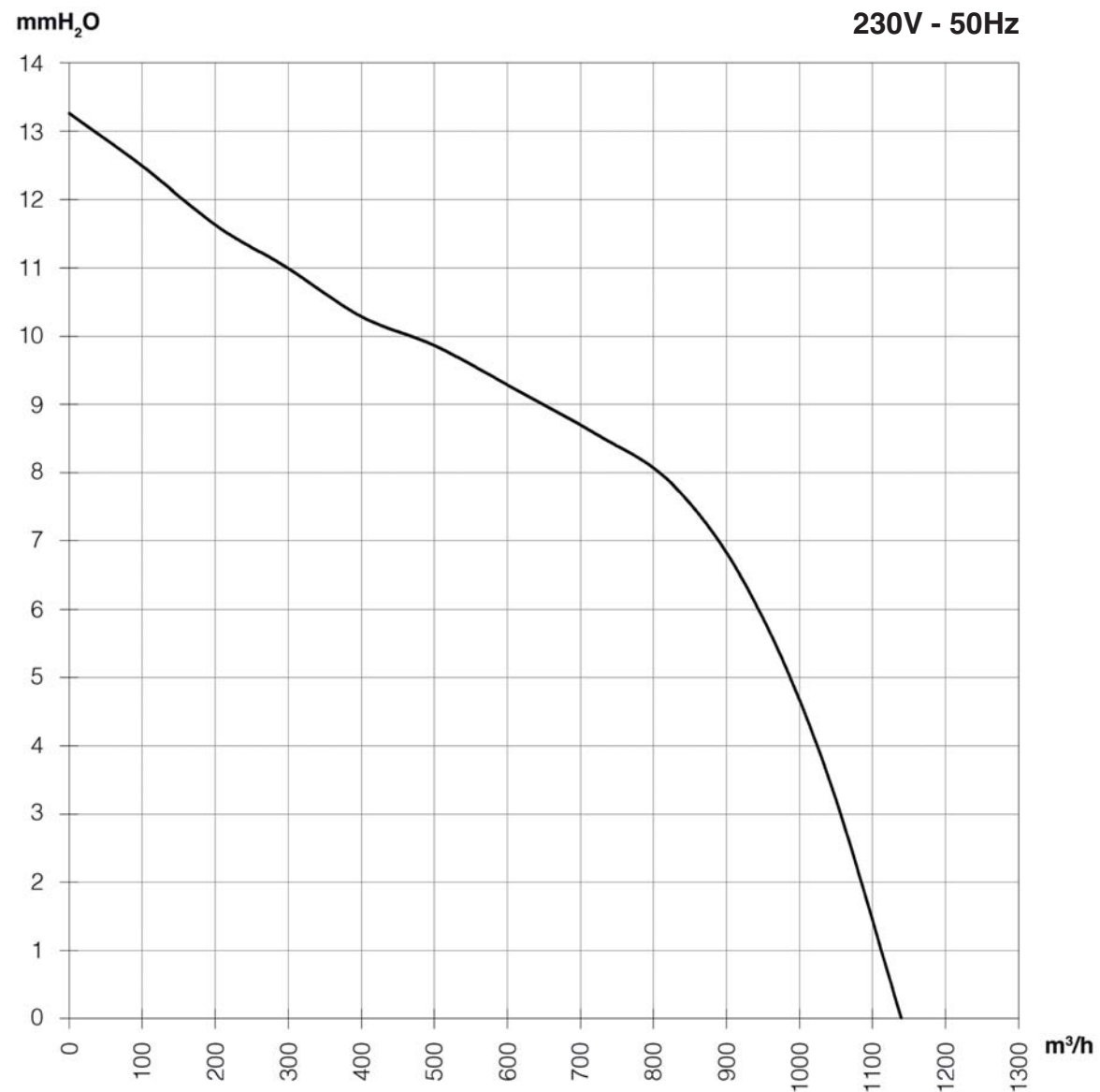
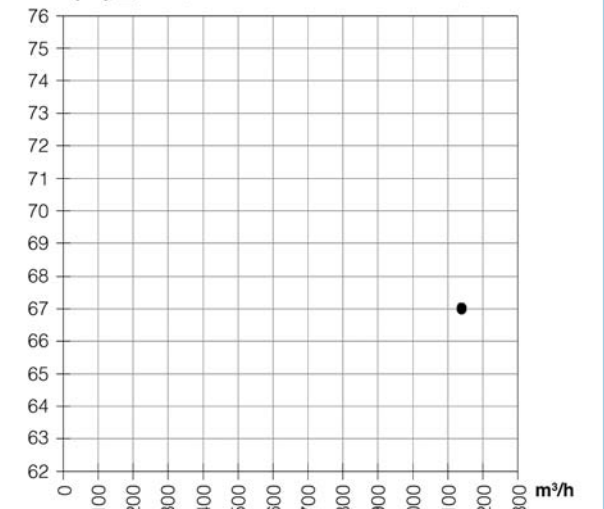



PERFORMANCE CURVES

DD 7/7 - 145-6P-3V 6 Poles

ErP Free

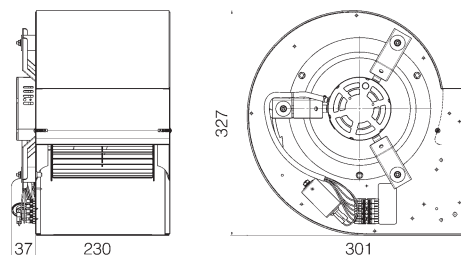

Ventilator Type: DD 7/7

Blowers Material: Metal
Housing Material: Metal
Motor Support Material: Metal

Motor Type: 3 FGM

Power Supply: 1 ~
Nominal Voltage: 230V
Frequency: 50-60 Hz
Nominal Watts: 145
Range Power: 200-254 V
Capacitor: 6.3 μ F

Electrical Insulation Class: Cl.F (155°C)
Protection: Thermally Prot.

Test: PDD-903 Web: 56

Operating limits Max Speed 50 Hz (Rating Values)

Win: Max 240 (W)
Ampere: Max 1.2 (A)
Static Pressure: Min 0 - Max 10 (mmH₂O)

Measurement Category - A - Free Inlet - Free Outlet

Value @ max. efficiency (Min Speed 50 Hz)

Air Flow: 658 (m³/h)
Static Pressure: 9.0 (mmH₂O)
Rpm: 883 (min⁻¹)
Power Input: **88 (W)**

Overall efficiency (η): 18.3
Grade efficiency (G): 31.2

dB(A)_LW (Sound Level Power @ Free Air)

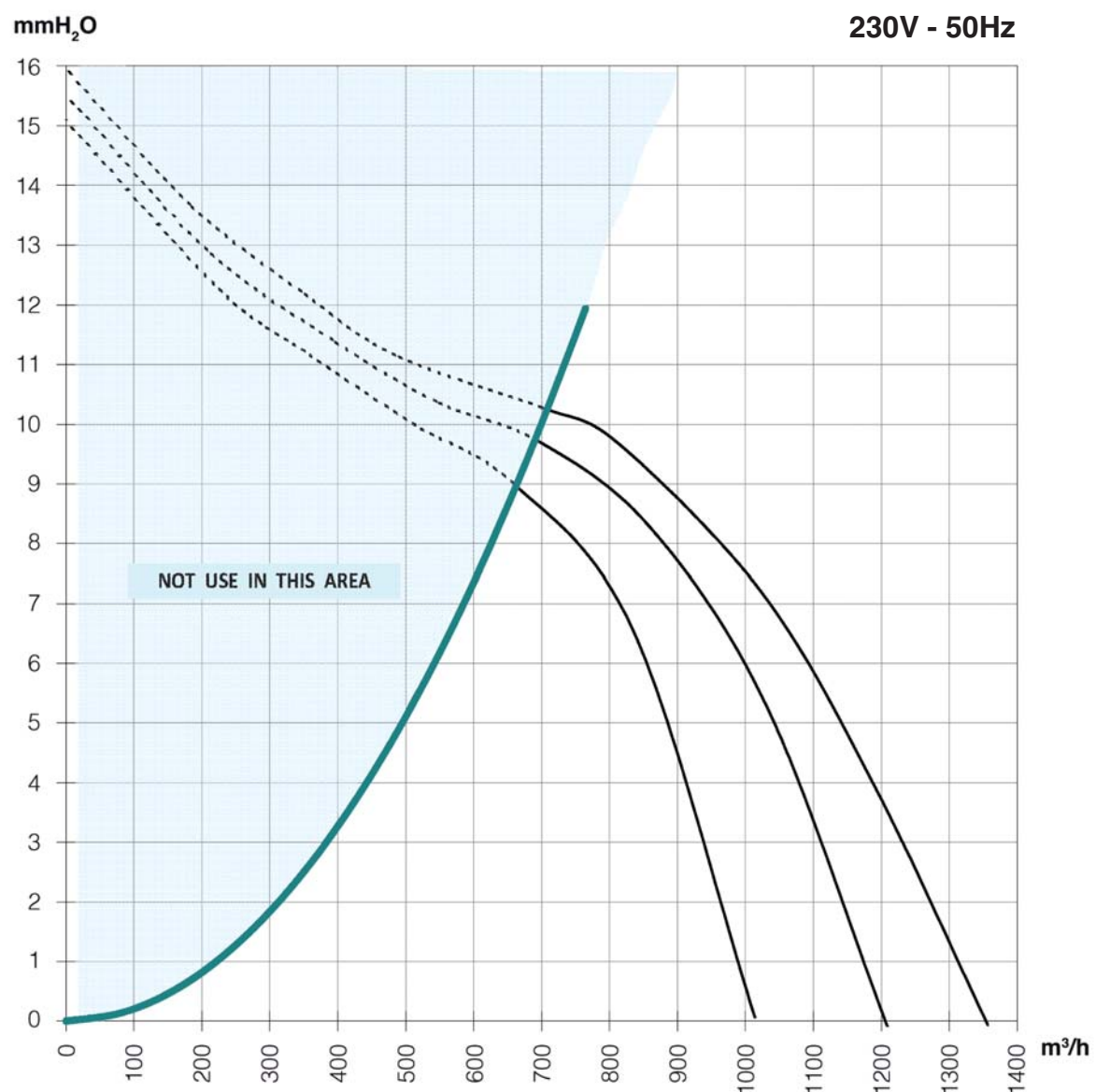
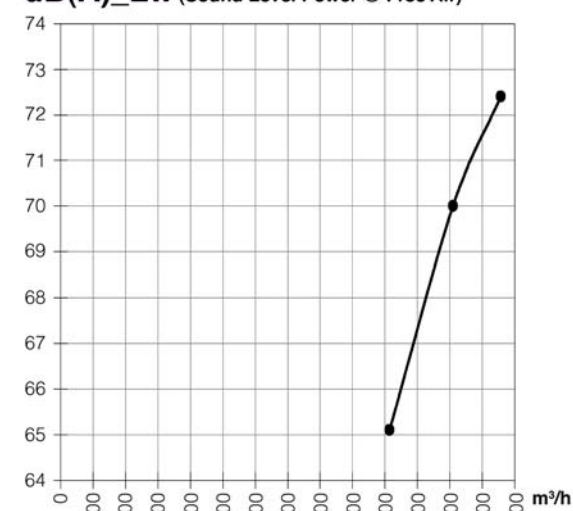

W in

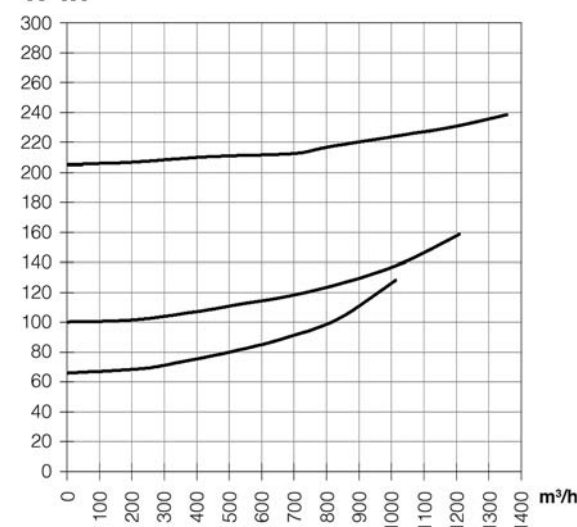

rpm

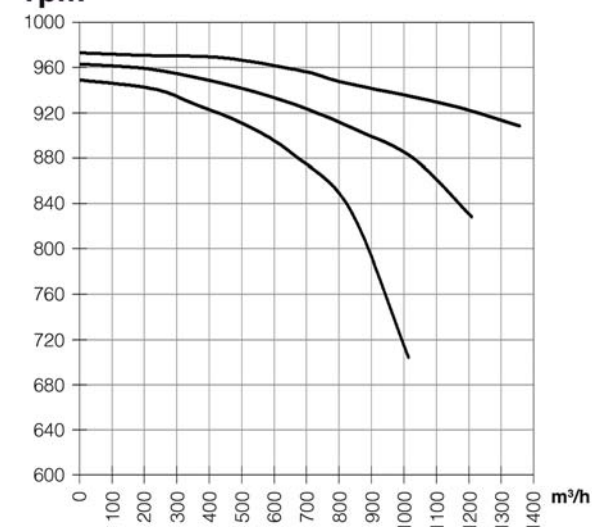

A

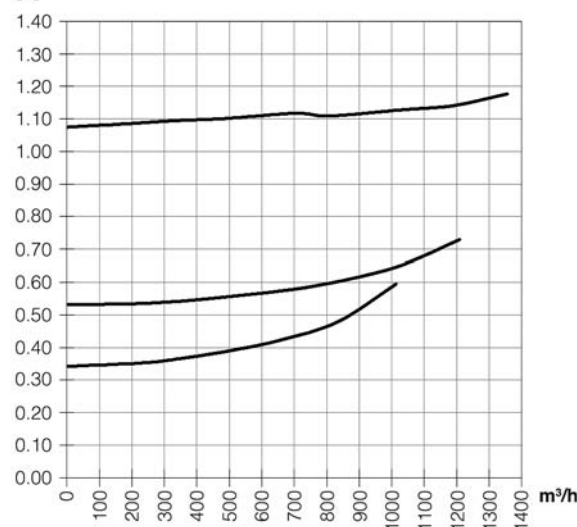

η static

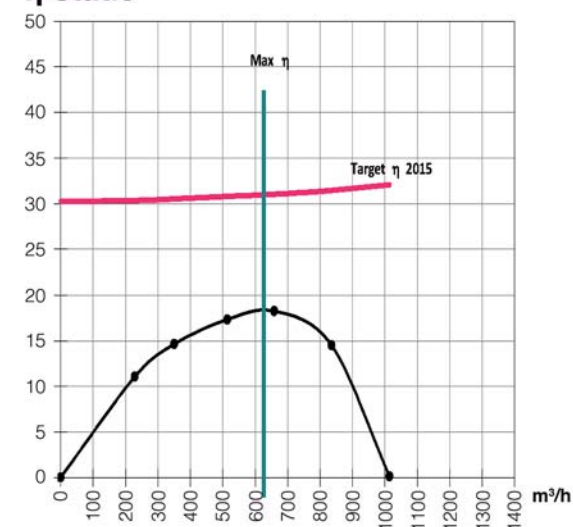



PERFORMANCE CURVES

DD 9/7 - 245-6P-3V 6 Poles

ErP 2015

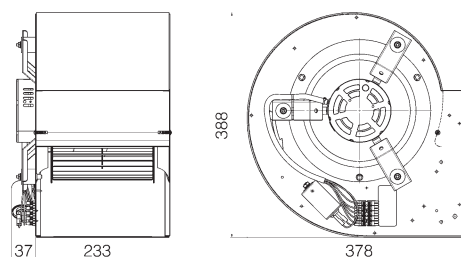

Ventilator Type: DD 9/7

Blowers Material: Metal
Housing Material: Metal
Motor Support Material: Metal

Motor Type: 3 FGM

Power Supply: 1 ~
Nominal Voltage: 230V
Frequency: 50-60 Hz
Nominal Watts: 245
Range Power: 200-254 V
Capacitor: 10 μ F

Electrical Insulation Class: Cl.F (155°C)
Protection: Thermally Prot.

Test: PDD-5051 Web: 487

Operating limits Max Speed 50 Hz (Rating Values)

Win: Max 510 (W)
Ampere: Max 2.3 (A)
Static Pressure: Min 0 - Max 20 (mmH₂O)

Measurement Category - A -

Free Inlet - Free Outlet

Value @ max. efficiency (Min Speed 50 Hz)

Air Flow: 1155 (m³/h)
Static Pressure: 17.0 (mmH₂O)
Rpm: 910 (min⁻¹)
Power Input: 164 (W)

Overall efficiency (η): 32.8

Grade efficiency (G): 44.1

dB(A)_LW (Sound Level Power @ Free Air)

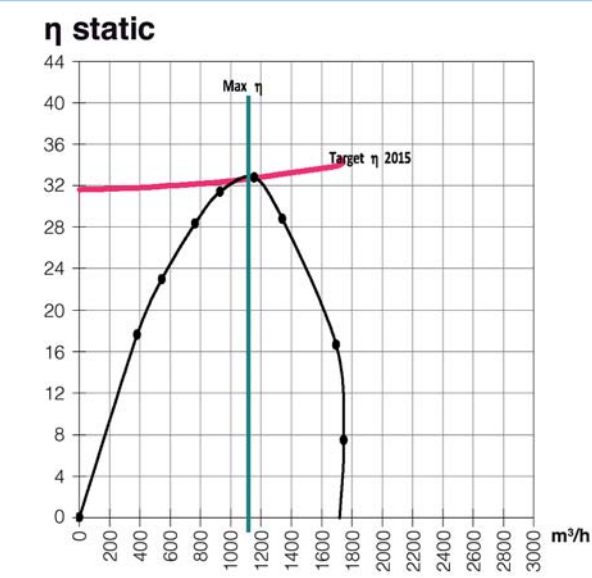
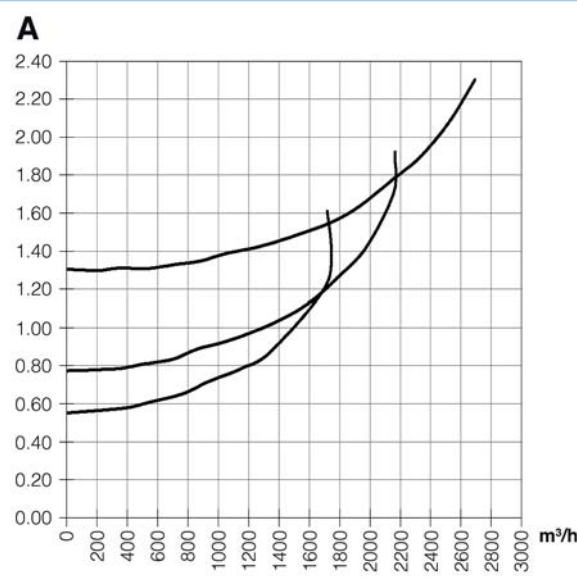
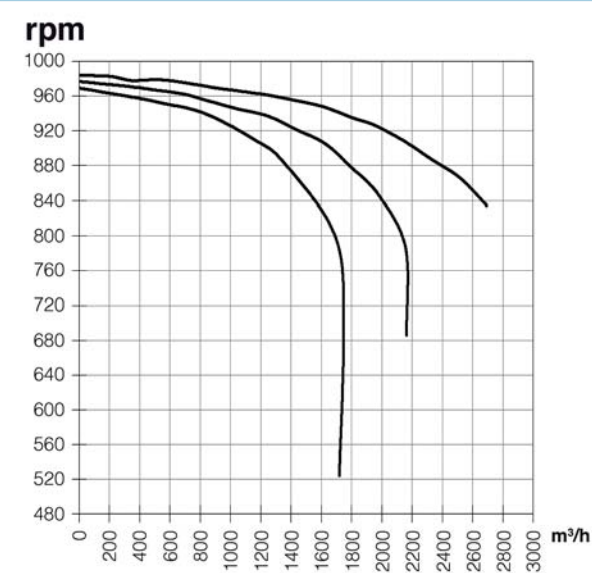
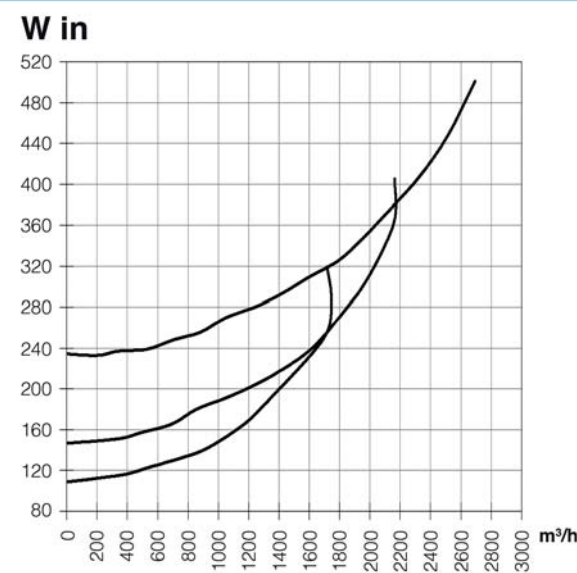
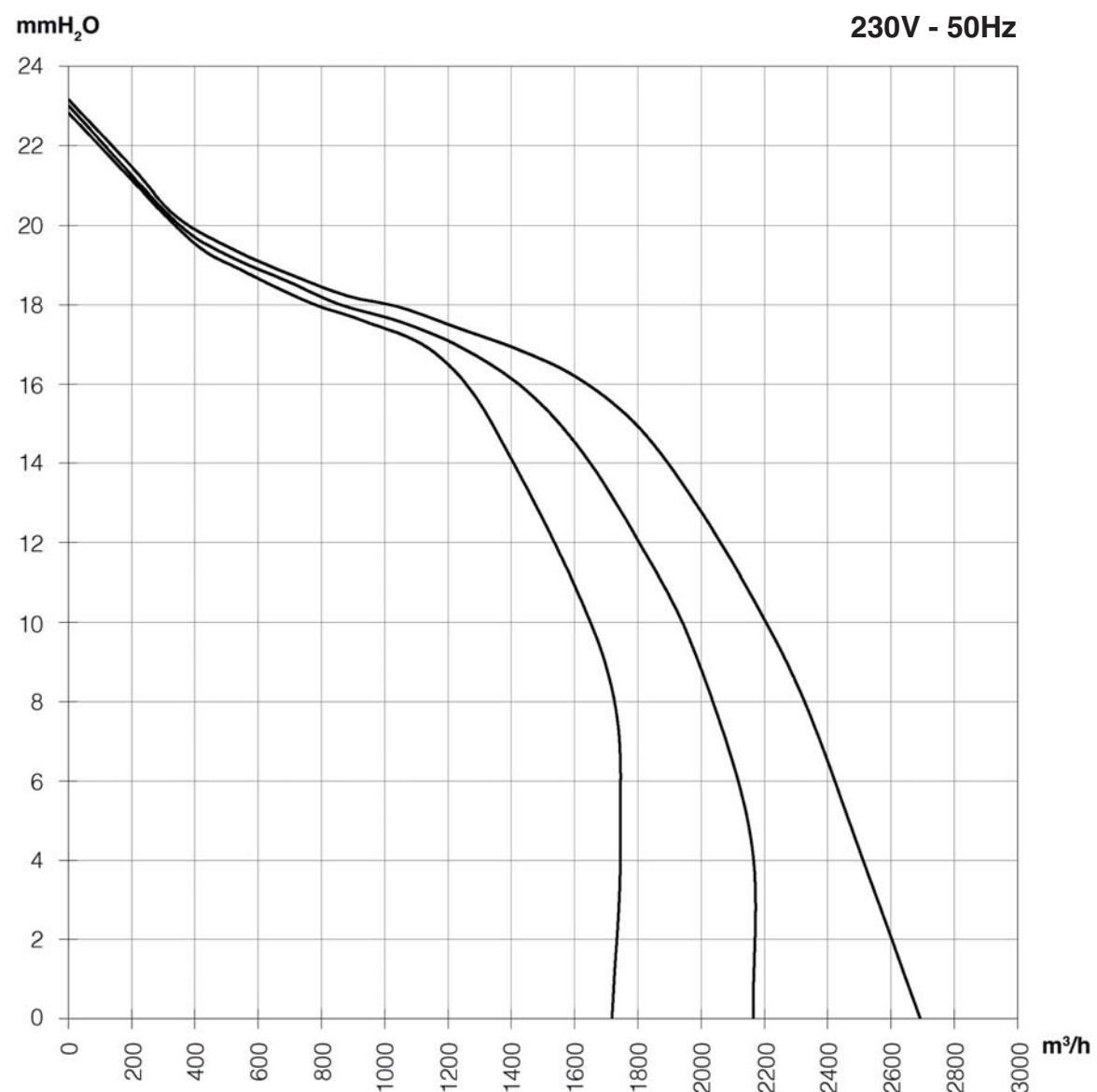
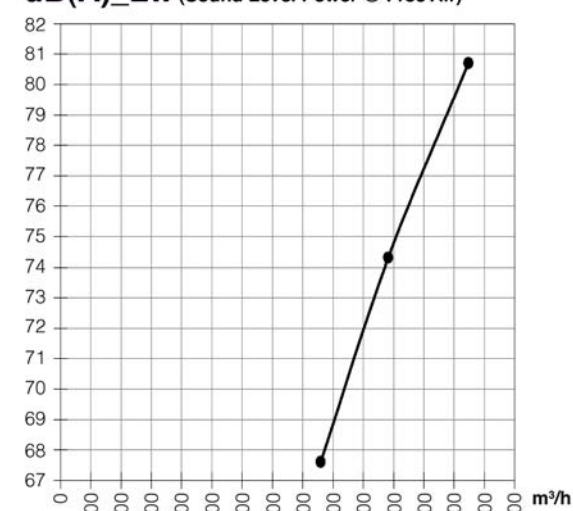



PERFORMANCE CURVES

DD 9/9 - 245-6P-3V 6 Poles

ErP 2015

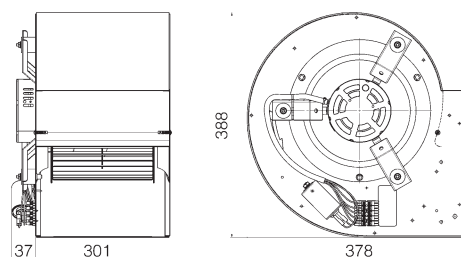

Ventilator Type: DD 9/9

Blowers Material: Metal
Housing Material: Metal
Motor Support Material: Metal

Motor Type: 3 FGM

Power Supply: 1 ~
Nominal Voltage: 230V
Frequency: 50-60 Hz
Nominal Watts: 245
Range Power: 200-254 V
Capacitor: 10 µF

Electrical Insulation Class: Cl.F (155°C)
Protection: Thermally Prot.

Test: PDD-5049 Web: 382

Operating limits Max Speed 50 Hz (Rating Values)

Win: Max 560 (W)
Ampere: Max 2.6 (A)
Static Pressure: Min 0 - Max 24 (mmH₂O)

Measurement Category - A -

Free Inlet - Free Outlet

Value @ max. efficiency (Min Speed 50 Hz)

Air Flow: 1004 (m³/h)
Static Pressure: 17.7 (mmH₂O)
Rpm: 914 (min⁻¹)
Power Input: 149 (W)

Overall efficiency (η): 32.5

Grade efficiency (G): 44.0

dB(A)_LW (Sound Level Power @ Free Air)

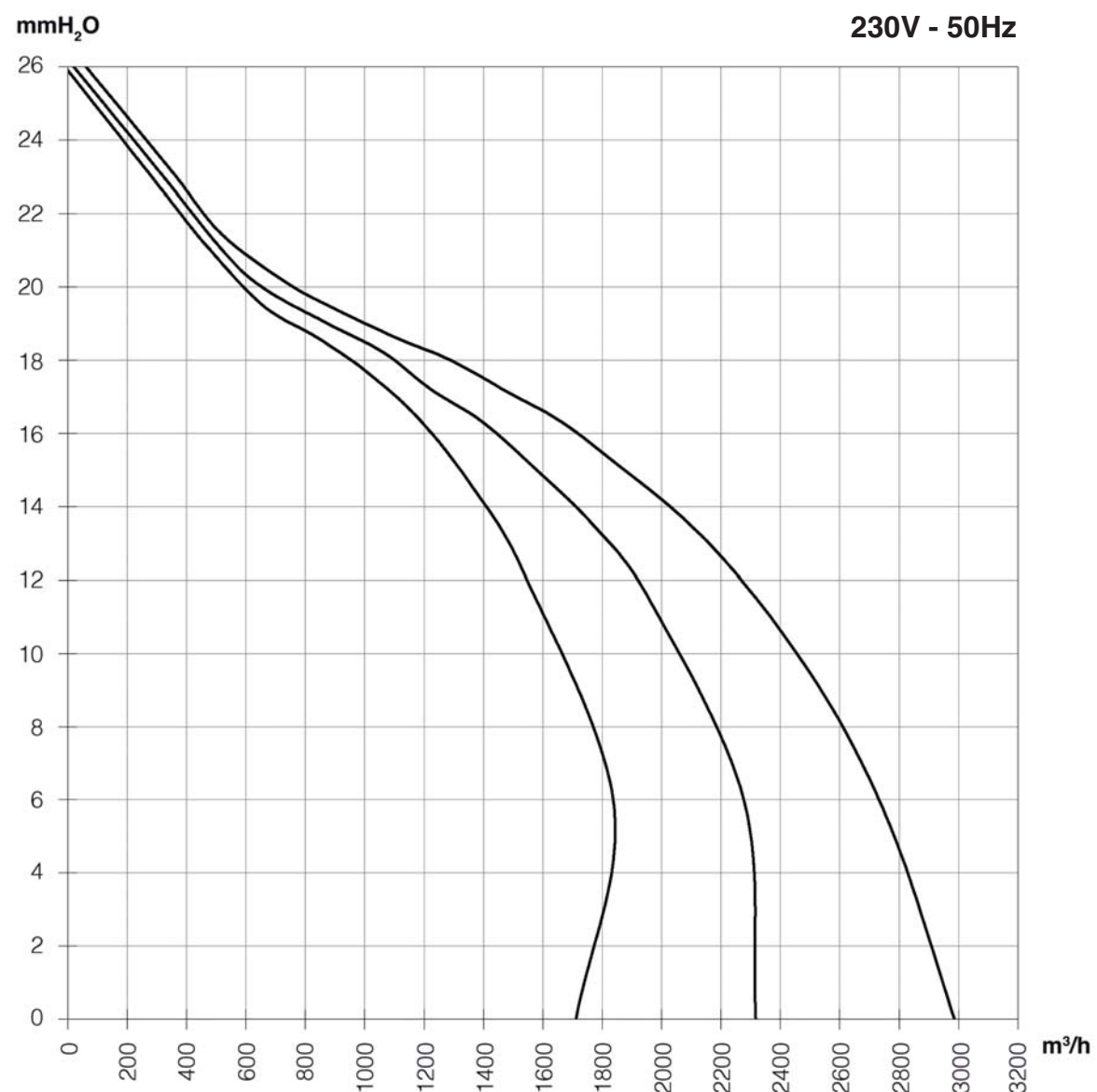
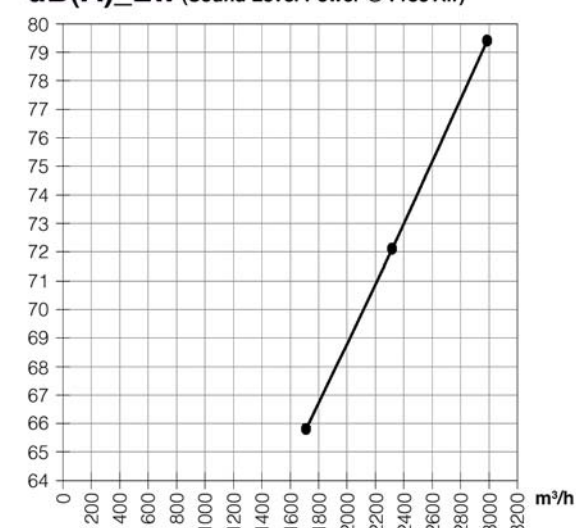

W in

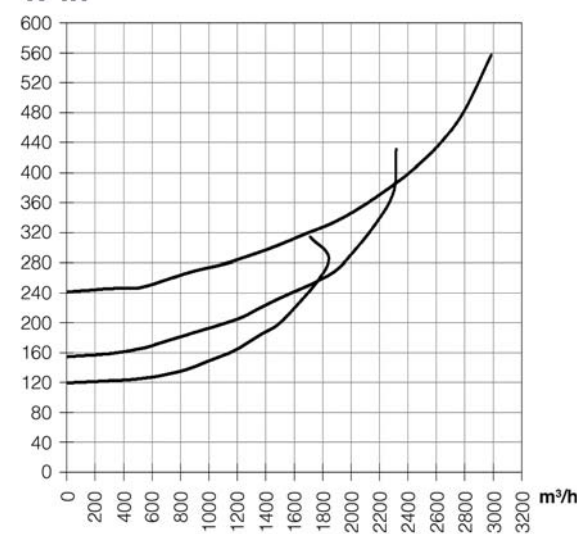

rpm

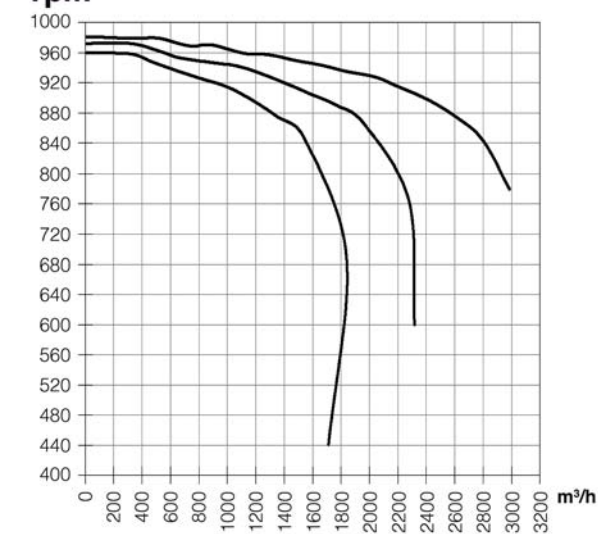

A

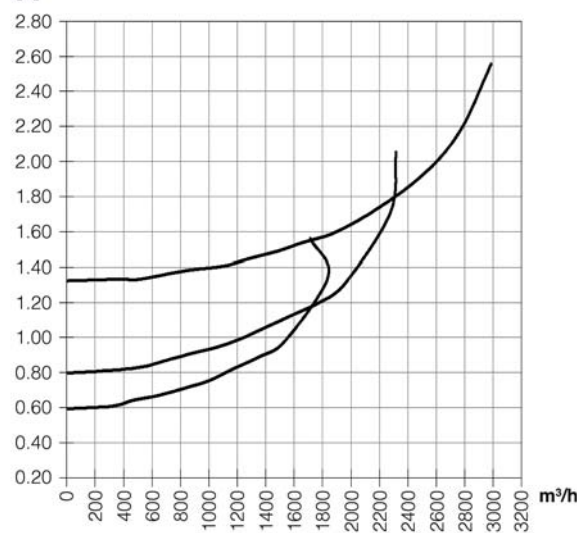

η static

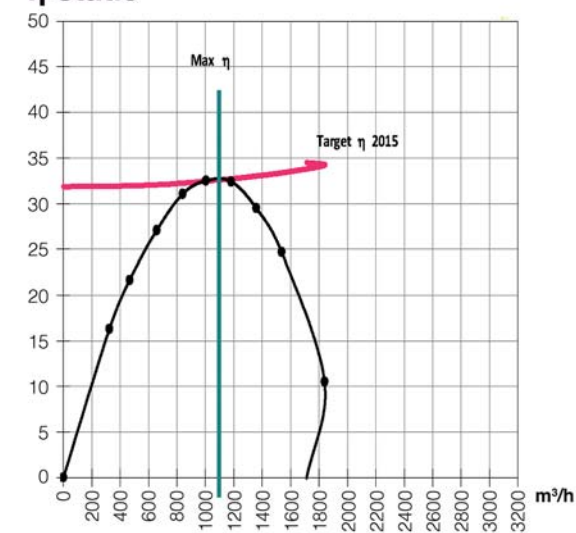



PERFORMANCE CURVES

DD 10/8 - 245-6P-3V 6 Poles

ErP 2015

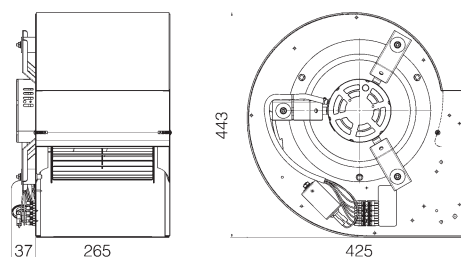

Ventilator Type: DD 10/8
 Blowers Material: Metal
 Housing Material: Metal
 Motor Support Material: Metal

Motor Type: 3 FGM
 Power Supply: 1 ~
 Nominal Voltage: 230V
 Frequency: 50-60 Hz
 Nominal Watts: 245
 Range Power: 200-254 V
 Capacitor: 12.5 μ F

Electrical Insulation Class: Cl.F (155°C)
 Protection: Thermally Prot.

Test: PDD-5062 Web: 488

Operating limits Max Speed 50 Hz (Rating Values)

Win: Max 640 (W)
 Ampere: Max 2.8 (A)
 Static Pressure: Min 0 - Max 24 (mmH₂O)

Measurement Category - A - Free Inlet - Free Outlet

Value @ max. efficiency (Min Speed 50 Hz)

Air Flow: 1424 (m³/h)
 Static Pressure: 19.2 (mmH₂O)
 Rpm: 859 (min-1)
 Power Input: 218 (W)

Overall efficiency (η): 34.2
 Grade efficiency (G): 44.7

dB(A)_LW (Sound Level Power @ Free Air)

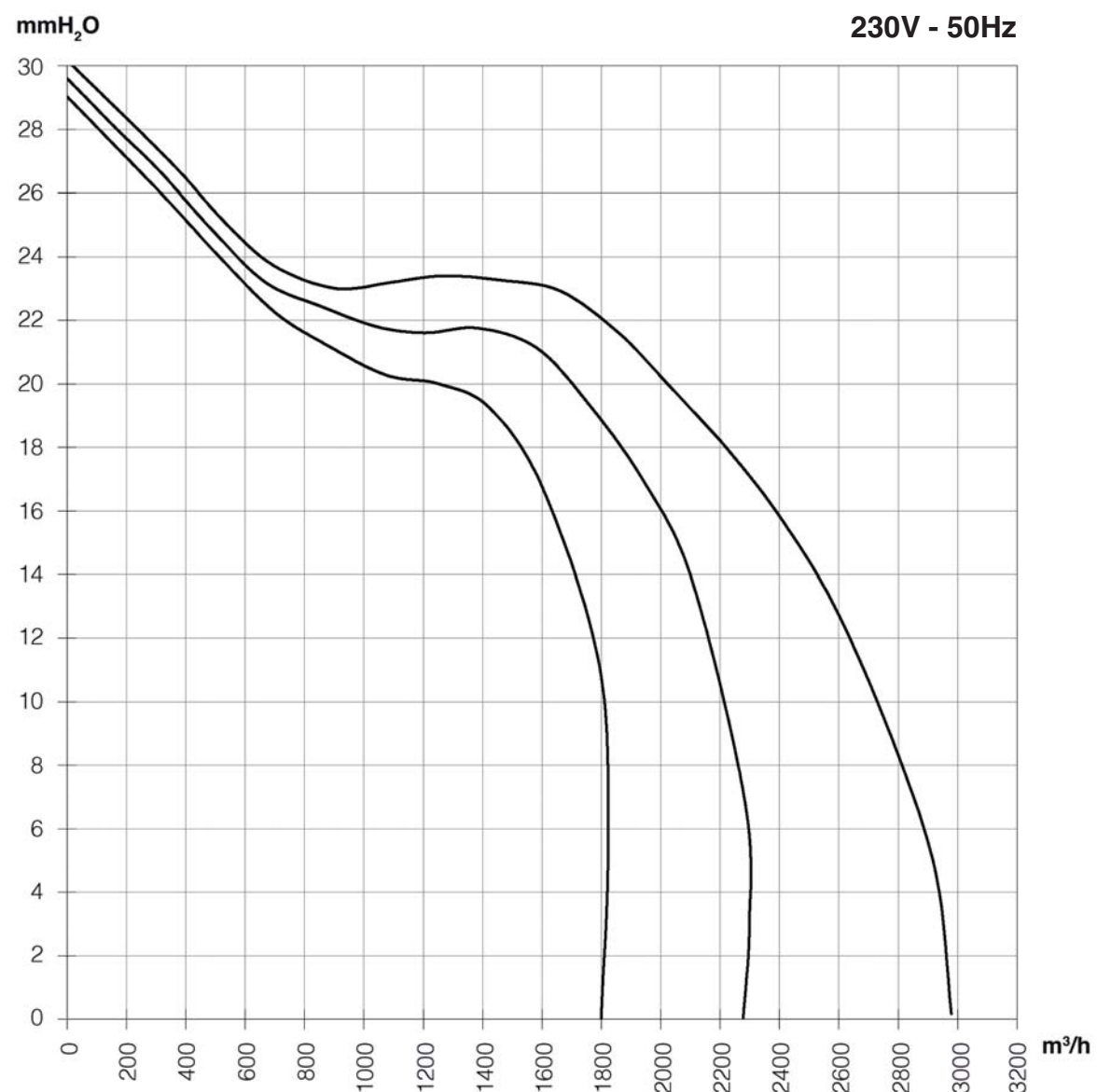
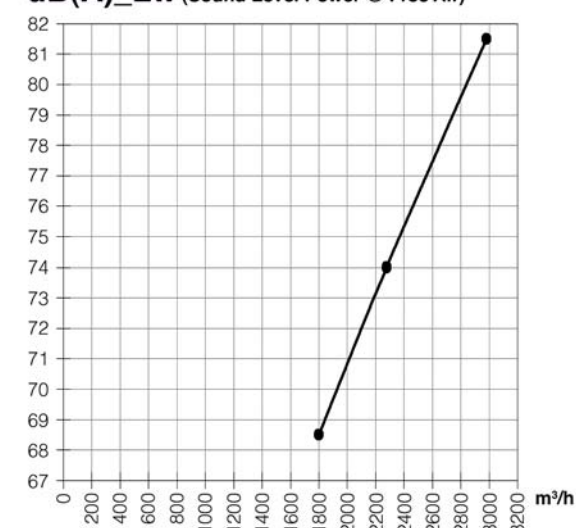

W in

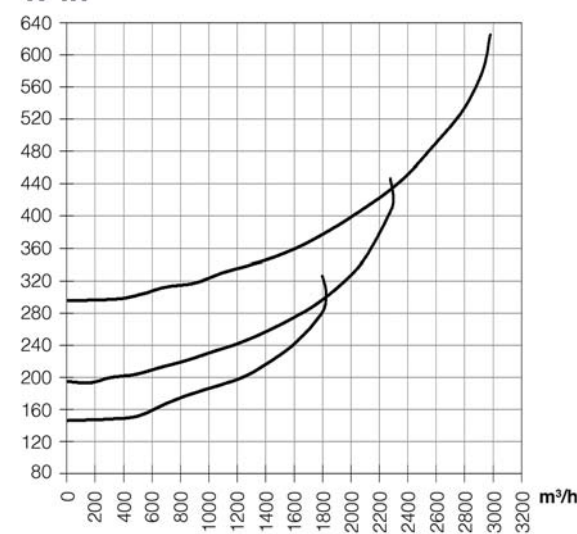

rpm

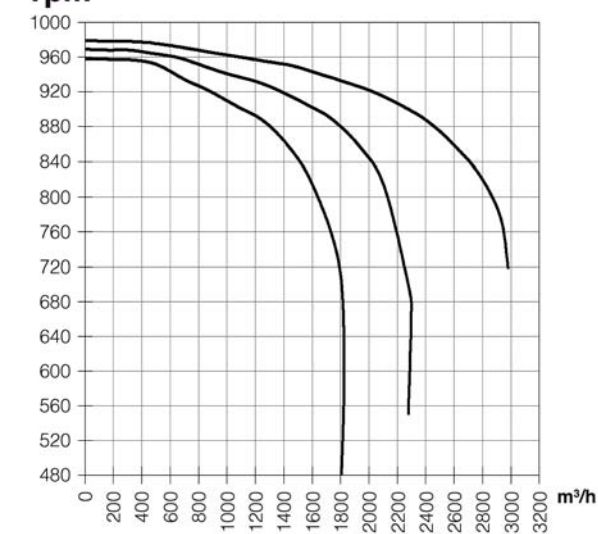

A

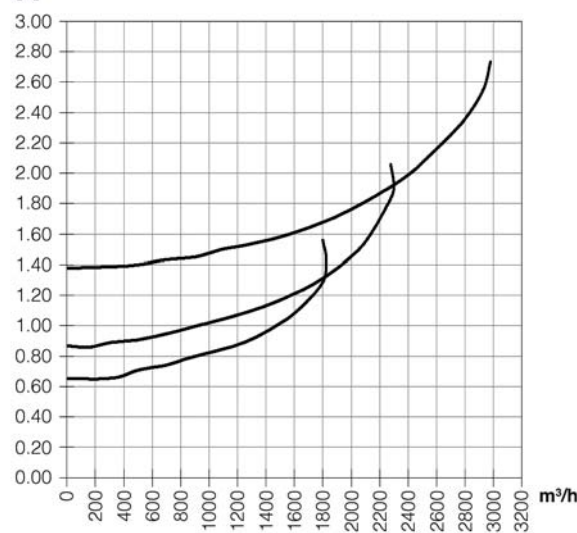

η static

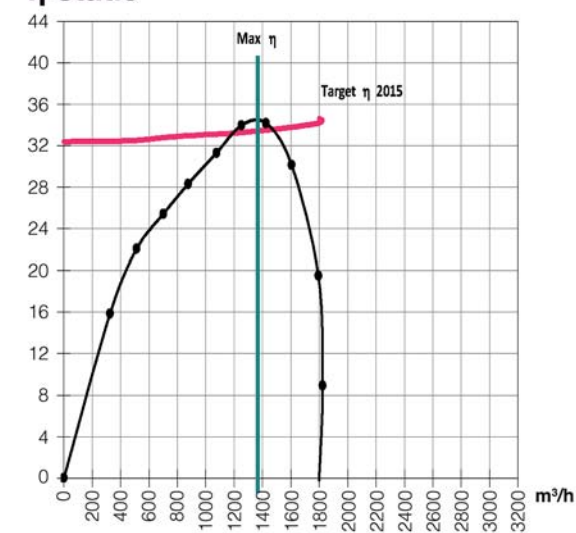



PERFORMANCE CURVES

DD 10/8 - 550-6P-3V 6 Poles

ErP 2015

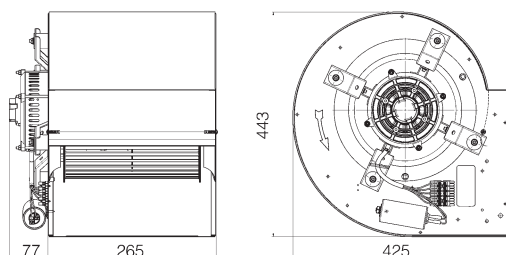

Ventilator Type: DD 10/8
 Blowers Material: Metal
 Housing Material: Metal
 Motor Support Material: Metal

Motor Type: 3 HOM
 Power Supply: 1 ~
 Nominal Voltage: 230V
 Frequency: 50-60 Hz
 Nominal Watts: 550
 Range Power: 200-254 V
 Capacitor: 18 μ F

Electrical Insulation Class: Cl.F (155°C)
 Protection: Thermally Prot.

Test: PDD-5082 Web: 341

Operating limits Max Speed 50 Hz (Rating Values)

Win: Max 750 (W)
 Ampere: Max 3.10 (A)
 Static Pressure: Min 0 - Max 24 (mmH₂O)

Measurement Category - A - Free Inlet - Free Outlet

Value @ max. efficiency (Min Speed 50 Hz)

Air Flow: 1572 (m³/h)
 Static Pressure: 22.3 (mmH₂O)
 Rpm: 960 (min⁻¹)
 Power Input: 242 (W)

Overall efficiency (η): 39.3
 Grade efficiency (G): 49.5

dB(A)_LW (Sound Level Power @ Free Air)

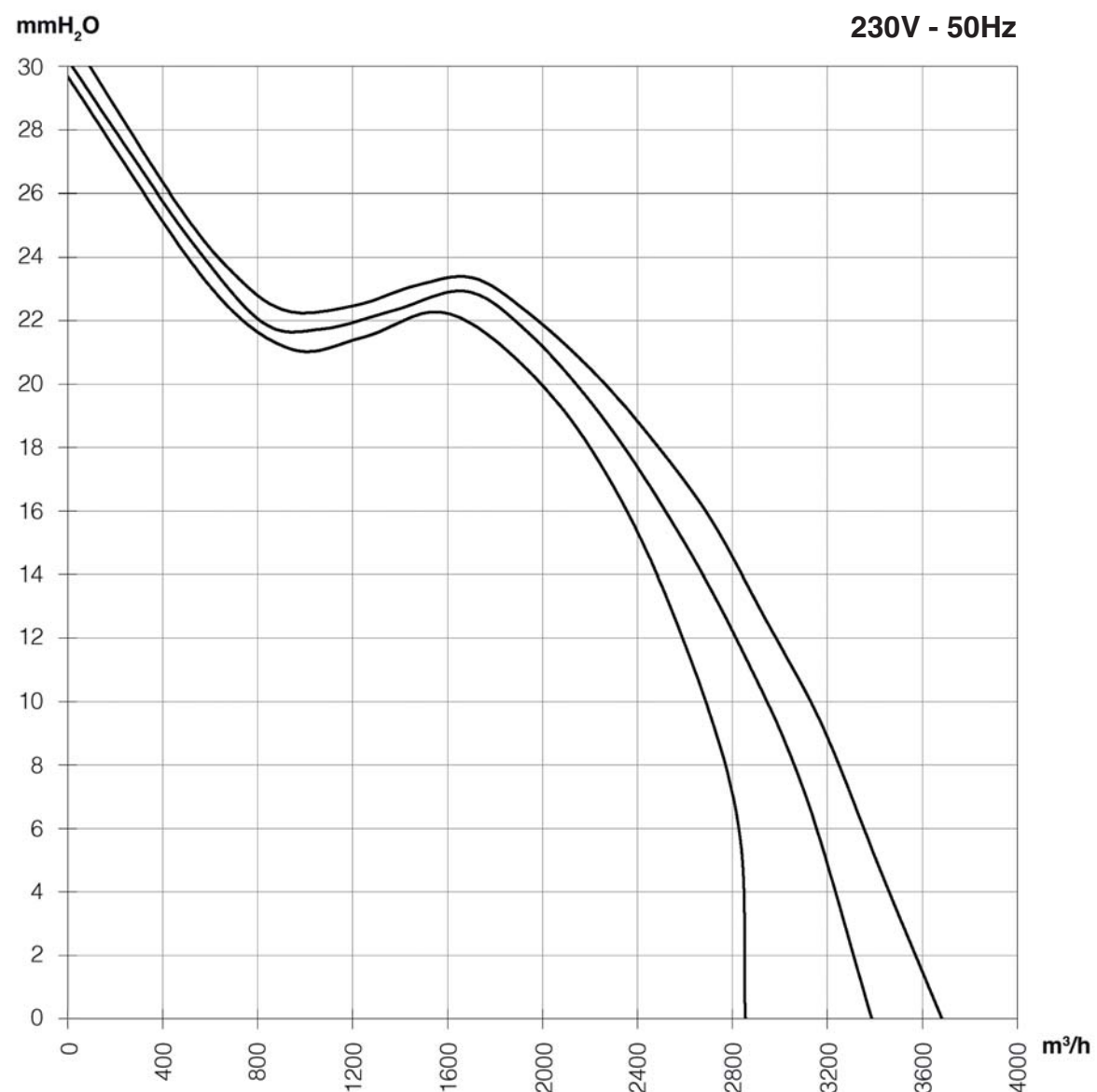
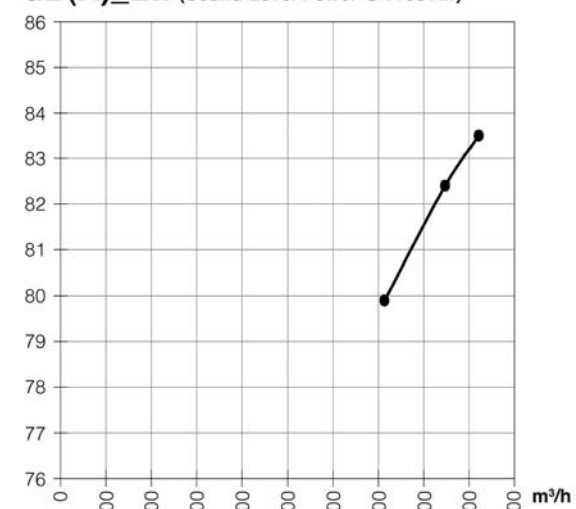

W in

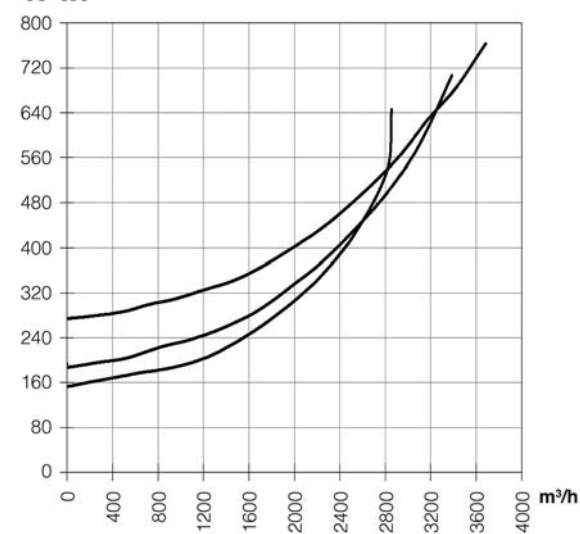

rpm

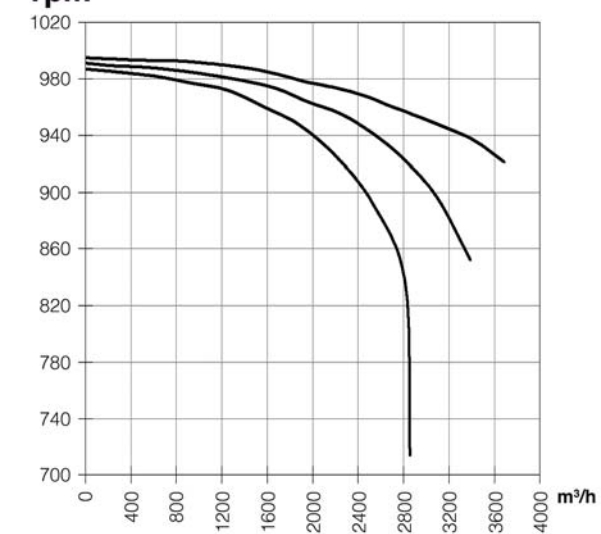

A

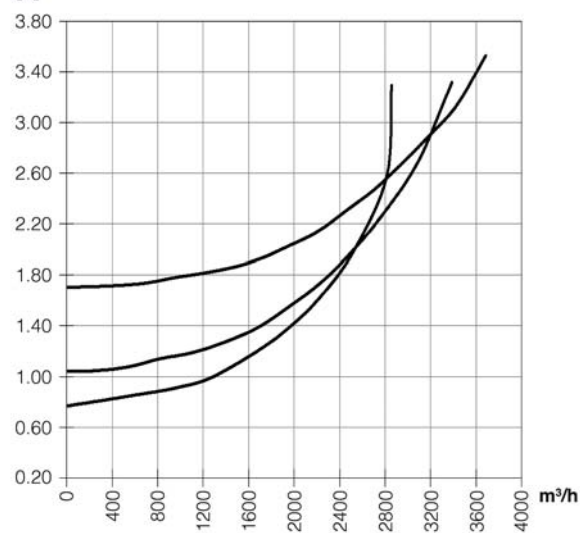

η static

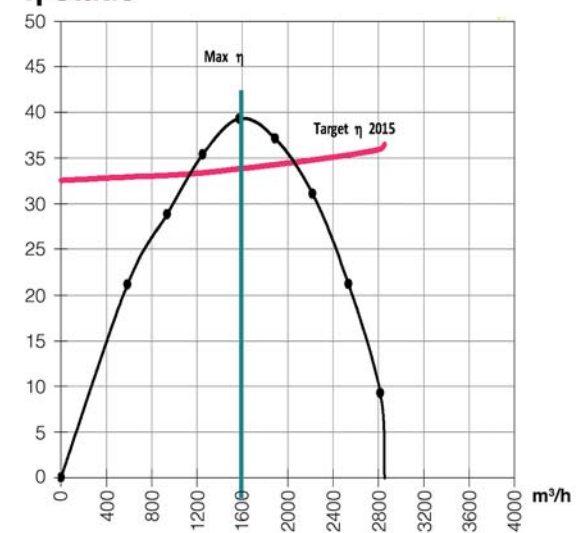



PERFORMANCE CURVES

DD 10/10 - 245-6P-3V 6 Poles

ErP 2015

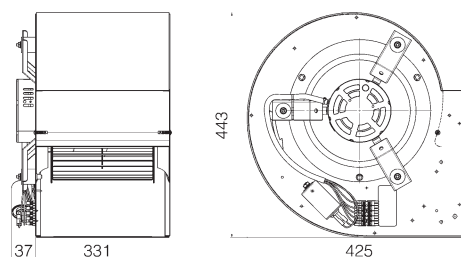

Ventilator Type: DD 10/10

Blowers Material: Metal
Housing Material: Metal
Motor Support Material: Metal

Motor Type: 3 FGM

Power Supply: 1 ~
Nominal Voltage: 230V
Frequency: 50-60 Hz
Nominal Watts: 245
Range Power: 200-254 V
Capacitor: 12.5 μ F

Electrical Insulation Class: Cl.F (155°C)
Protection: Thermally Prot.

Test: PDD-5058 Web: 383

Operating limits Max Speed 50 Hz (Rating Values)

Win: Max 660 (W)
Ampere: Max 3.0 (A)
Static Pressure: Min 0 - Max 26 (mmH₂O)

Measurement Category - A -

Free Inlet - Free Outlet

Value @ max. efficiency (Med Speed 50 Hz)

Air Flow: 1865 (m³/h)
Static Pressure: 20.0 (mmH₂O)
Rpm: 875 (min⁻¹)
Power Input: 295 (W)

Overall efficiency (η): 34.4

Grade efficiency (G): 44.1

dB(A)_LW (Sound Level Power @ Free Air)

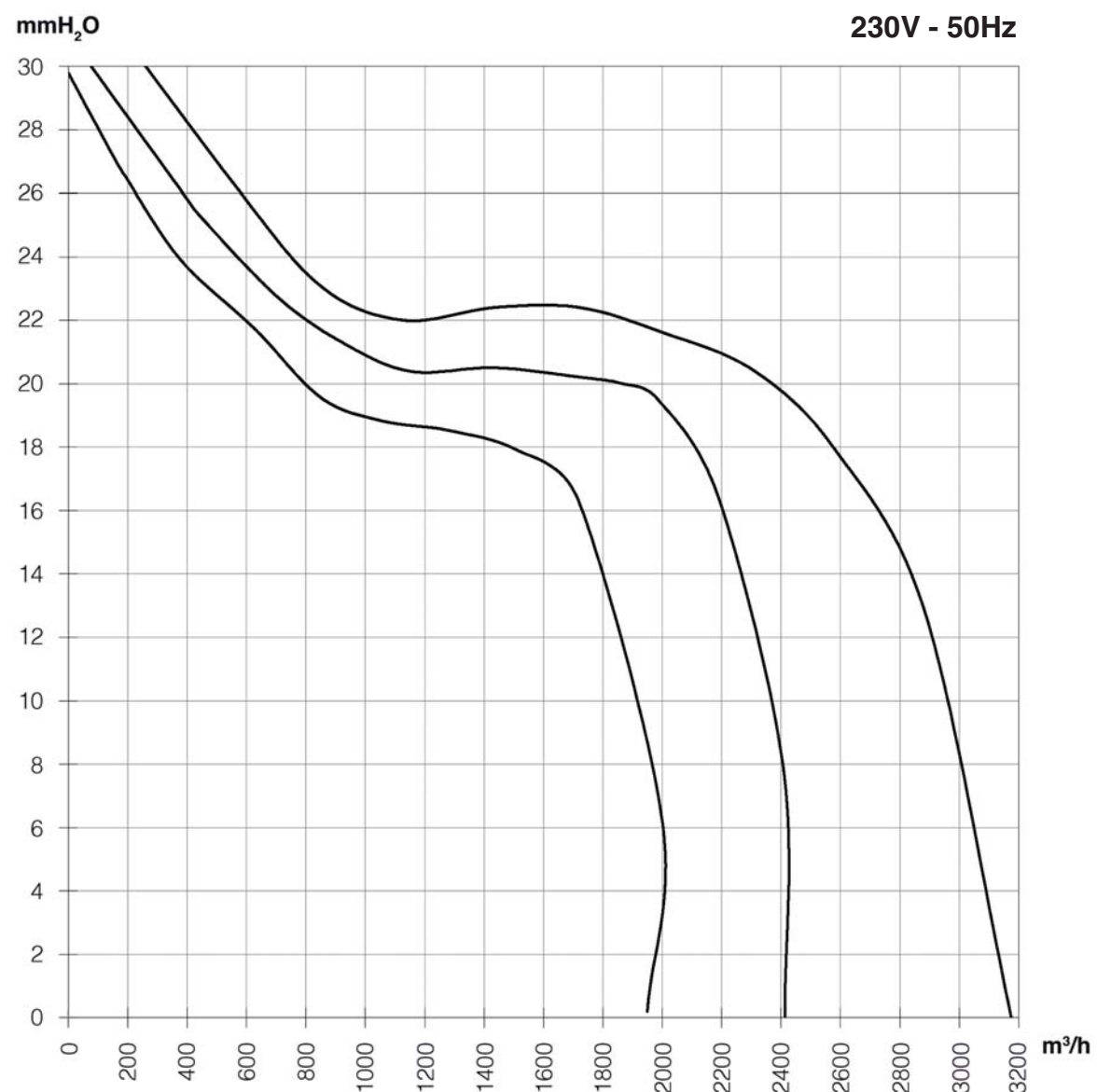
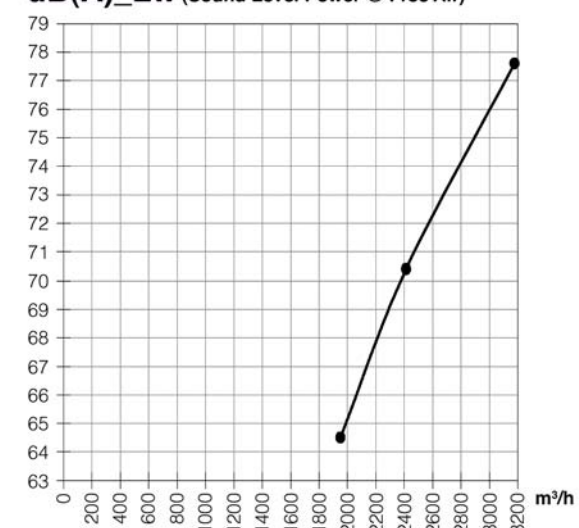

W in

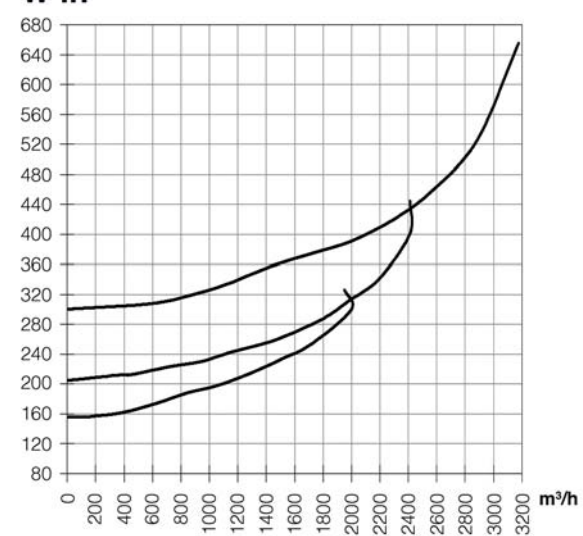

rpm

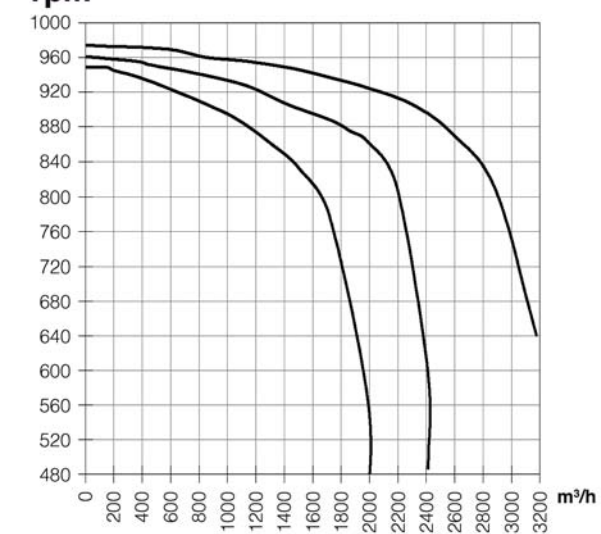

A

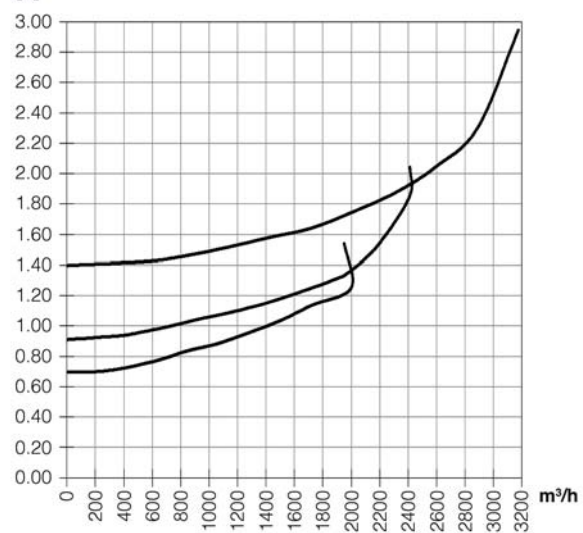

η static

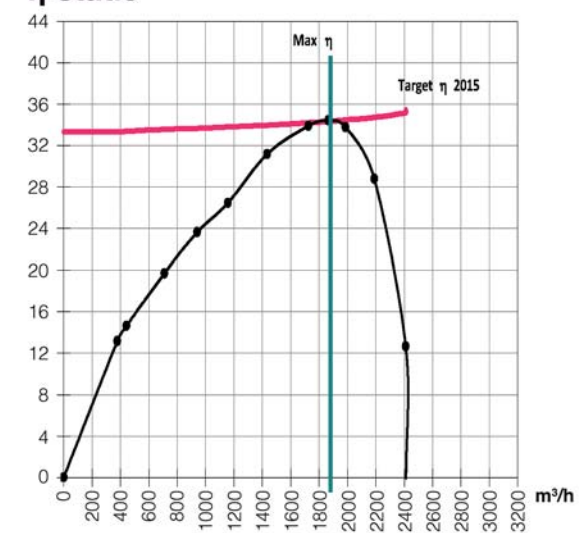



PERFORMANCE CURVES

DD 10/10 - 550-6P-3V 6 Poles

ErP 2015

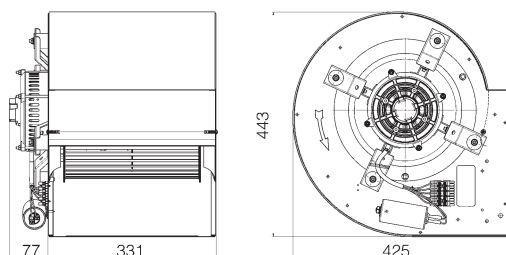

Ventilator Type: DD 10/10

Blowers Material: Metal
Housing Material: Metal
Motor Support Material: Metal

Motor Type: 3 HOM

Power Supply: 1 ~
Nominal Voltage: 230V
Frequency: 50-60 Hz
Nominal Watts: 550
Range Power: 200-254 V
Capacitor: 18 µF

Electrical Insulation Class: Cl.F (155°C)
Protection: Thermally Prot.

Test: PDD-5067 Web: 388

Operating limits Max Speed 50 Hz (Rating Values)

Win: Max 950 (W)
Ampere: Max 4.5 (A)
Static Pressure: Min 0 - Max 25 (mmH₂O)

Measurement Category - A -

Free Inlet - Free Outlet

Value @ max. efficiency (Min Speed 50 Hz)

Air Flow: 1851 (m³/h)
Static Pressure: 20.6 (mmH₂O)
Rpm: 942 (min⁻¹)
Power Input: 301 (W)

Overall efficiency (η): 34.5

Grade efficiency (G): 44.2

dB(A)_LW (Sound Level Power @ Free Air)

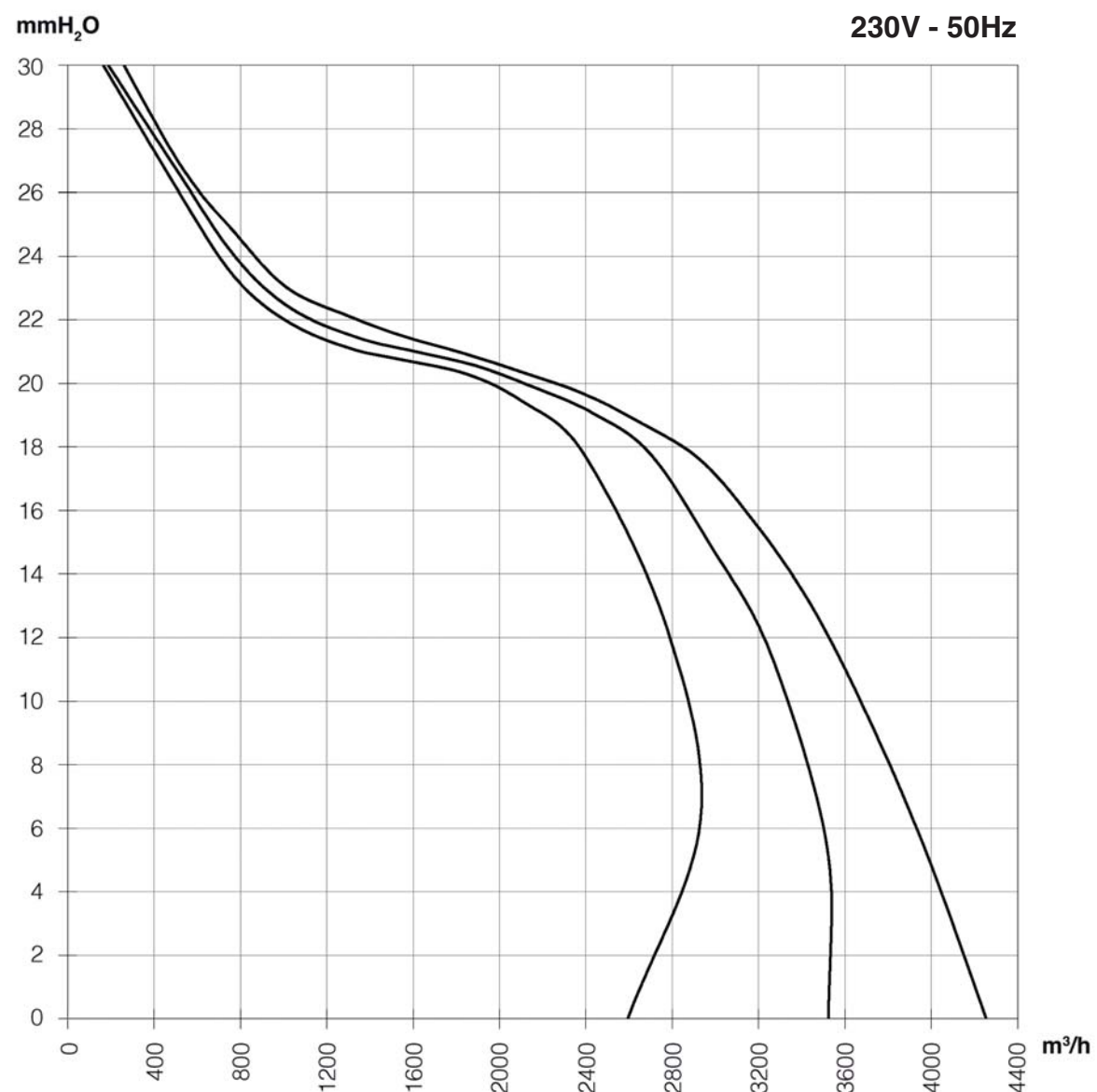
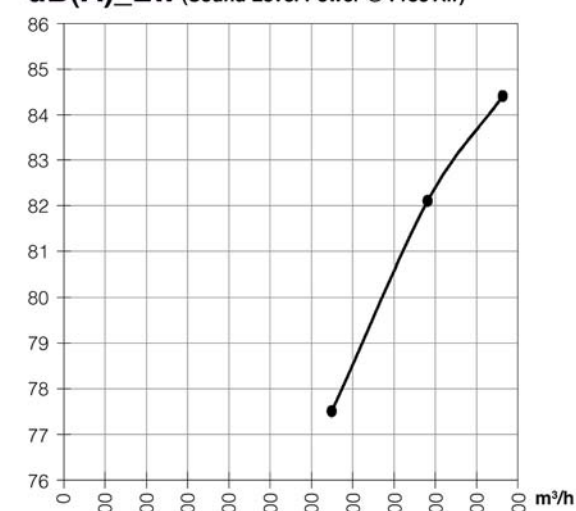

W in

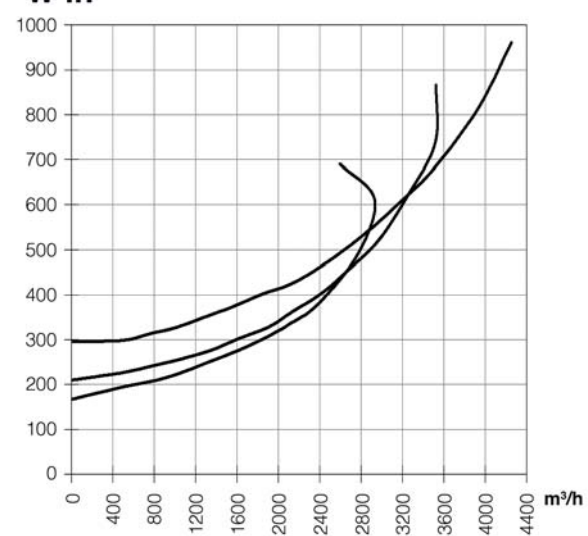

rpm

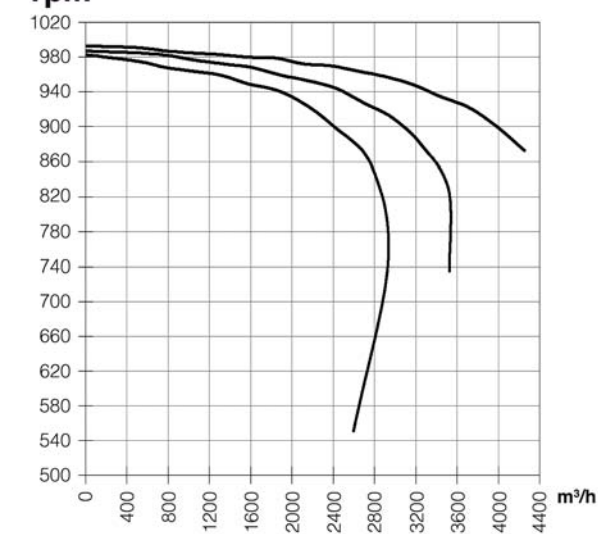

A

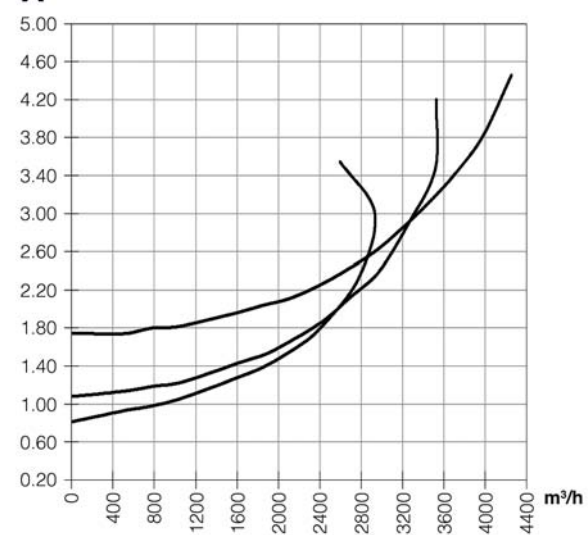

η static

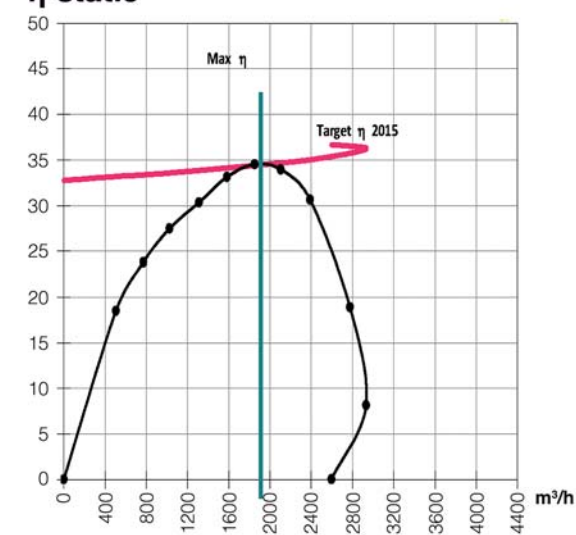



PERFORMANCE CURVES

DD 12/9 - 550-6P-3V 6 Poles

ErP 2015

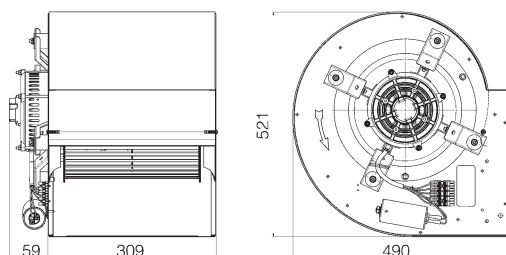

Ventilator Type: DD 12/9
 Blowers Material: Metal
 Housing Material: Metal
 Motor Support Material: Metal

Motor Type: 3 HOM
 Power Supply: 1 ~
 Nominal Voltage: 230V
 Frequency: 50-60 Hz
 Nominal Watts: 550
 Range Power: 200-254 V
 Capacitor: 20 µF

Electrical Insulation Class: Cl.F (155°C)
 Protection: Thermally Prot.

Test: PDD-5072 Web: 489

Operating limits Max Speed 50 Hz (Rating Values)

Win: Max 1360 (W)
 Ampere: Max 6.2 (A)
 Static Pressure: Min 0 - Max 35 (mmH₂O)

Measurement Category - A - Free Inlet - Free Outlet

Value @ max. efficiency (Med Speed 50 Hz)

Air Flow: 2204 (m³/h)
 Static Pressure: 31.3 (mmH₂O)
 Rpm: 918 (min⁻¹)
 Power Input: 456 (W)

Overall efficiency (η): 41.2
 Grade efficiency (G): 49.7

dB(A)_LW (Sound Level Power @ Free Air)

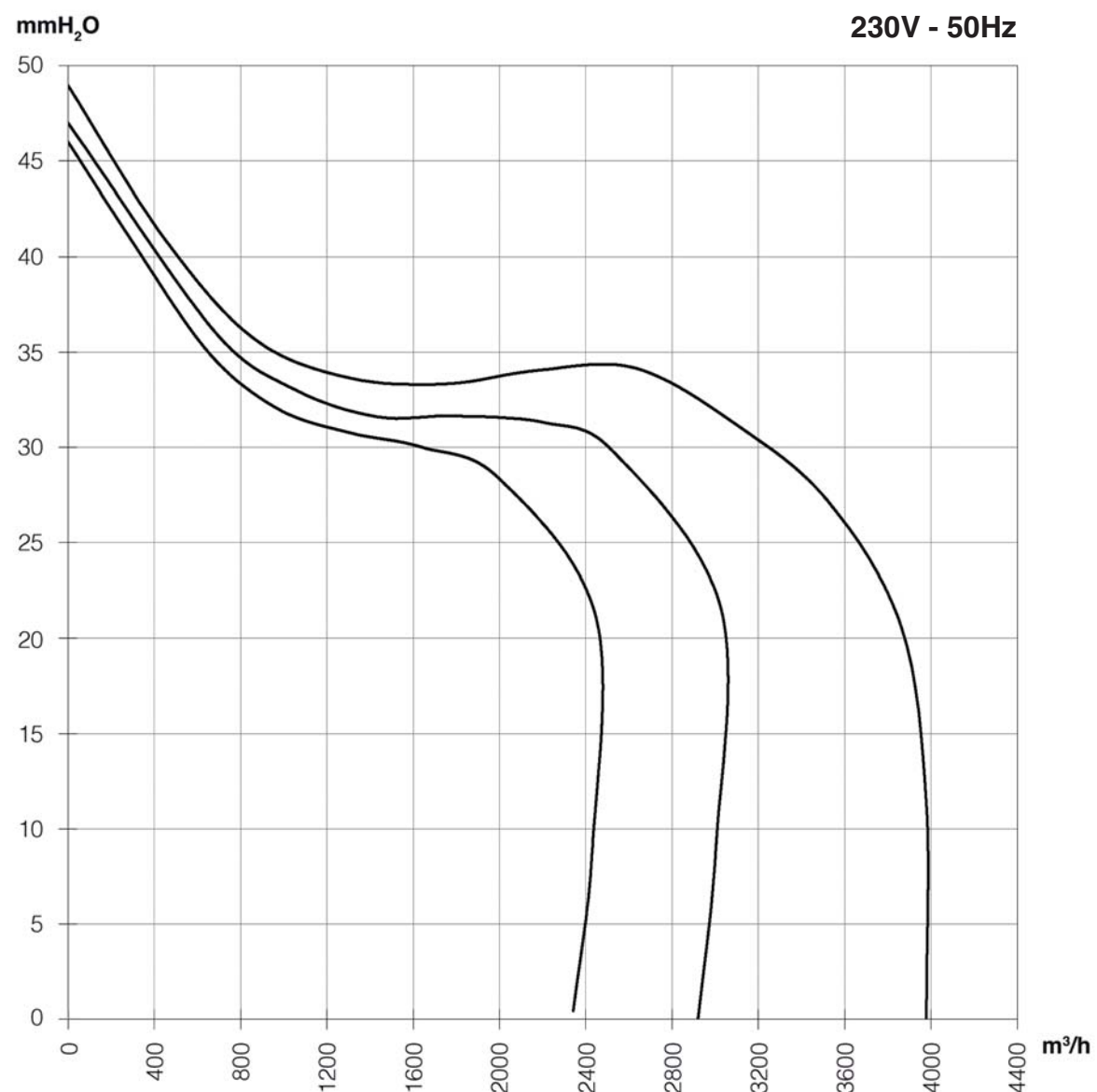
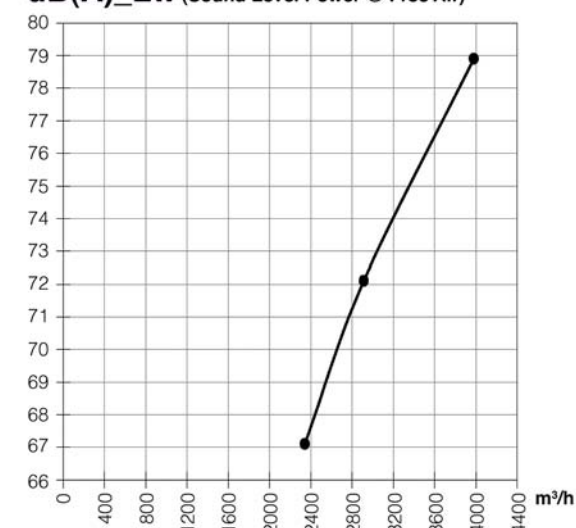

W in

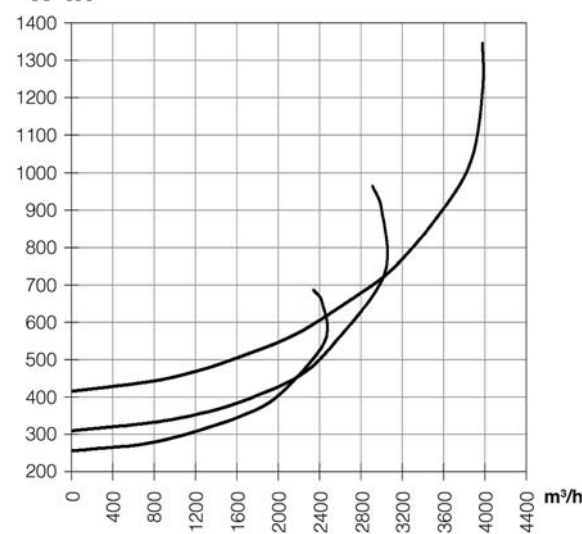

rpm

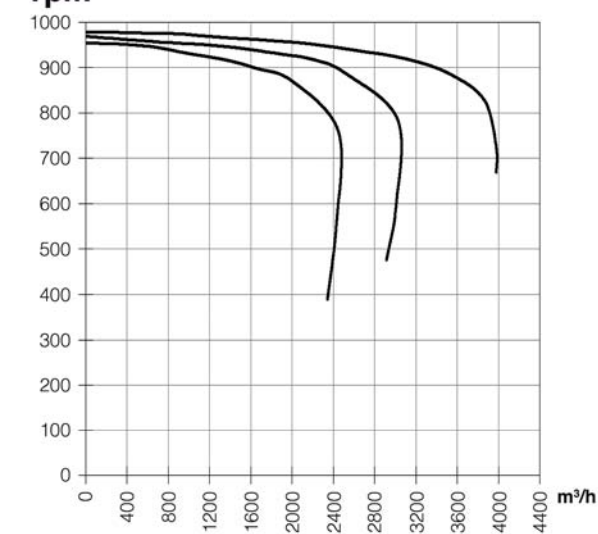

A

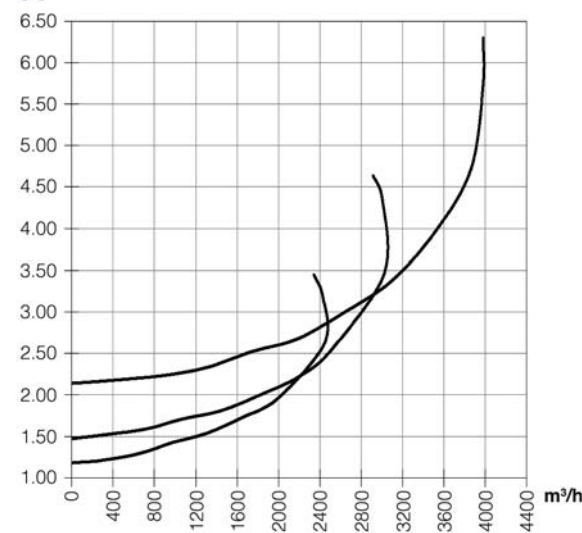

η static

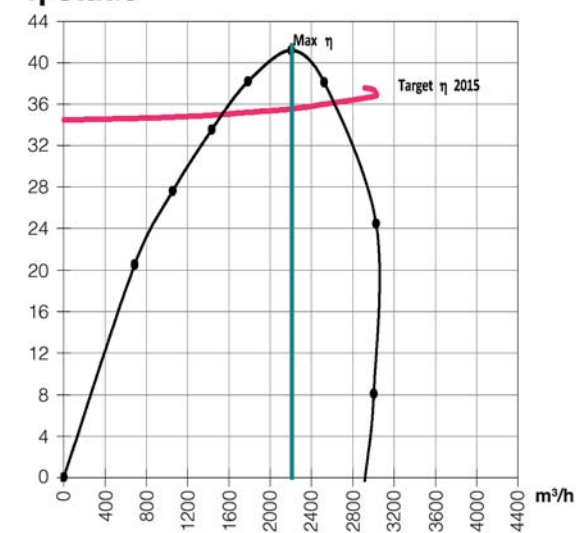



PERFORMANCE CURVES

DD 12/9 - 735-6P-3V 6 Poles

ErP 2015

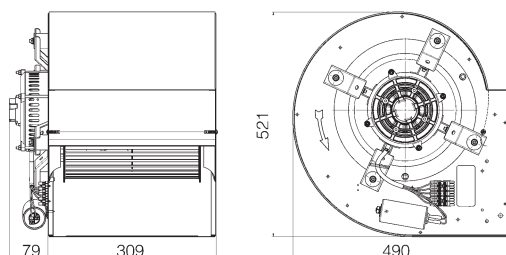

Ventilator Type: DD 12/9
 Blowers Material: Metal
 Housing Material: Metal
 Motor Support Material: Metal

Motor Type: 3 HOM
 Power Supply: 1 ~
 Nominal Voltage: 230V
 Frequency: 50-60 Hz
 Nominal Watts: 735
 Range Power: 200-254 V
 Capacitor: 20 µF

Electrical Insulation Class: Cl.F (155°C)
 Protection: Thermally Prot.

Test: PDD-5015 Web: 490

Operating limits Max Speed 50 Hz (Rating Values)

Win: Max 1600 (W)
 Ampere: Max 7.8 (A)
 Static Pressure: Min 5 - Max 40 (mmH₂O)

Measurement Category - A - Free Inlet - Free Outlet

Value @ max. efficiency (Min Speed 50 Hz)

Air Flow: 2278 (m³/h)
 Static Pressure: 30.3 (mmH₂O)
 Rpm: 929 (min⁻¹)
 Power Input: 464 (W)

Overall efficiency (η): 40.4
 Grade efficiency (G): 48.9

dB(A)_LW (Sound Level Power @ Free Air)

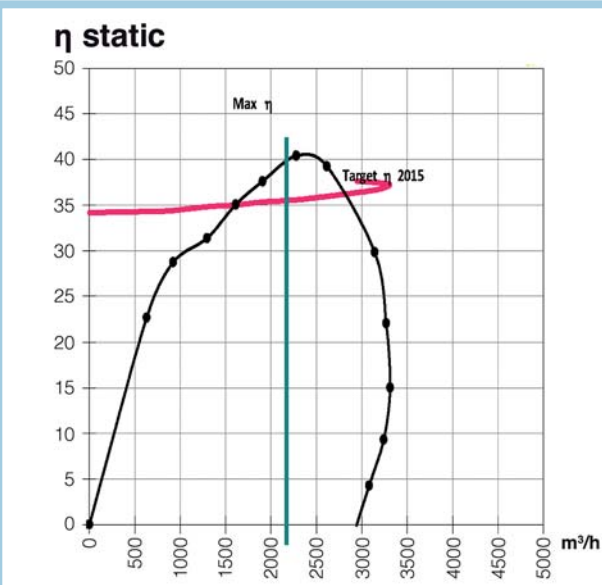
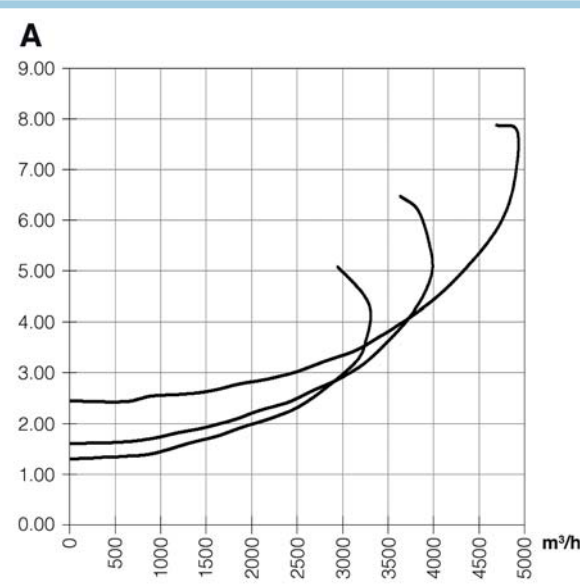
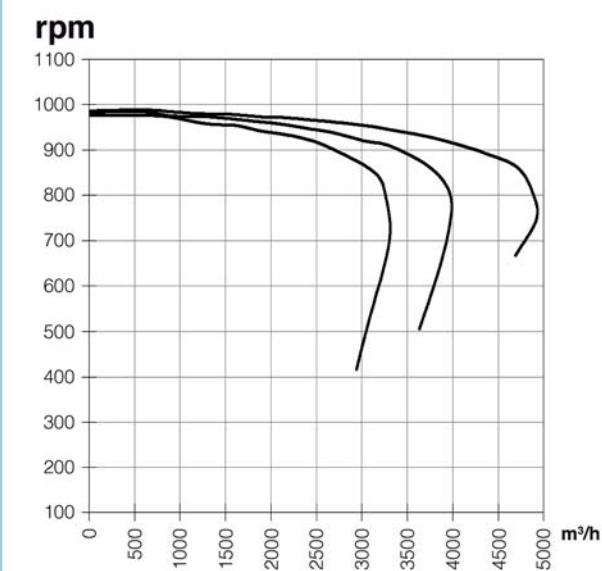
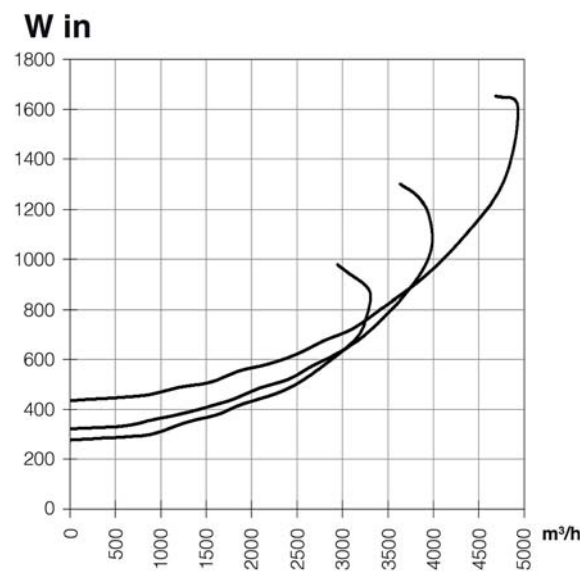
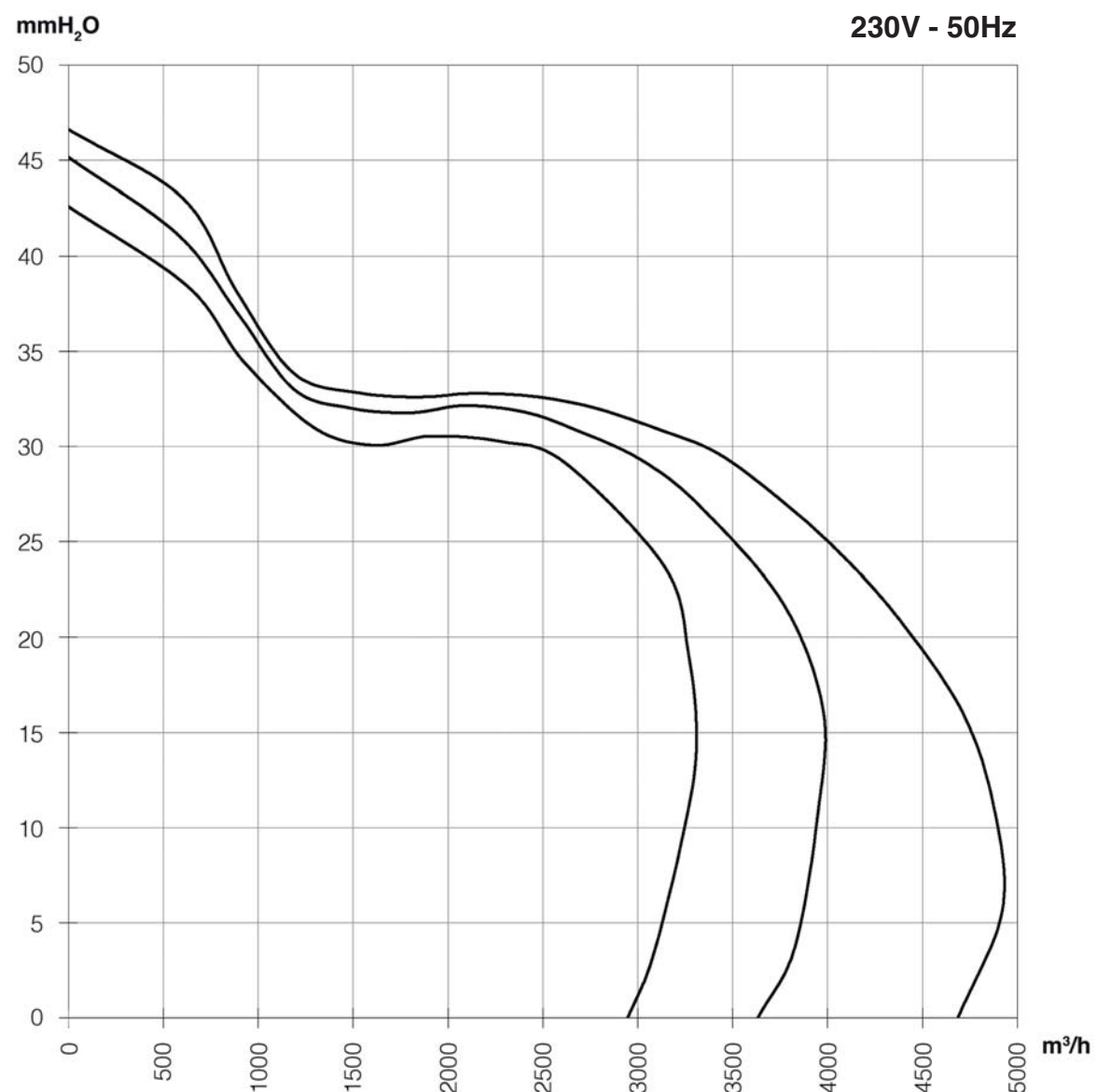
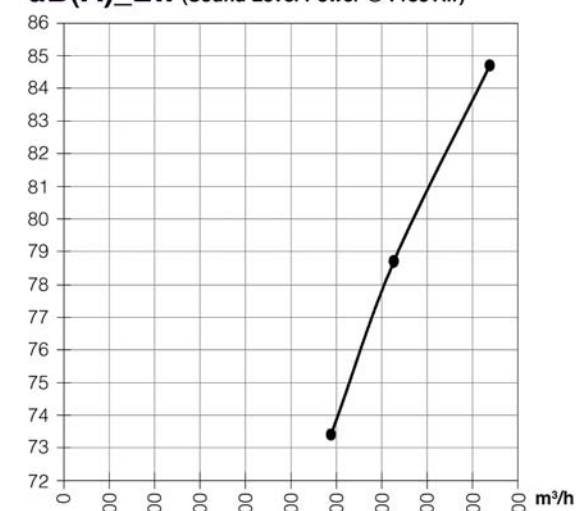



PERFORMANCE CURVES

DD 12/9 - 1100-6P-1V-T 6 Poles

ErP 2015

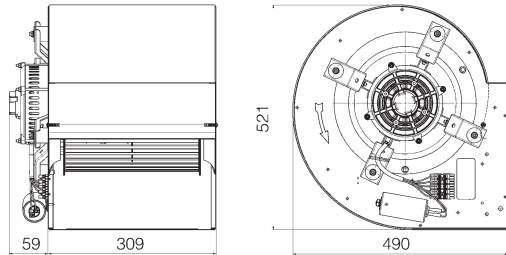

Ventilator Type: DD 12/9
 Blowers Material: Metal
 Housing Material: Metal
 Motor Support Material: Metal

Motor Type: 3 HOM
 Power Supply: 3 ~
 Nominal Voltage: 230V (Δ) - 400V (Y)
 Frequency: 50-60 Hz
 Nominal Watts: 1100

Range Power: 200-254 V (Δ)
 360-440 V (Y)

Electrical Insulation Class: Cl.F (155°C)
 Protection: Thermally Prot.

Test: PDD-5013 Web: 491

Operating limits Max Speed 50 Hz (Rating Values)
 Win: Max 1600 (W)
 Ampere: Max 3.1 A (Δ) - 5.4 A (Y)
 Static Pressure: Min 0 - Max 40 (mmH₂O)

Measurement Category - A -
Free Inlet - Free Outlet

Value @ max. efficiency (50 Hz)
 Air Flow: 2857 (m³/h)
 Static Pressure: 33.0 (mmH₂O)
 Rpm: 969 (min-1)
 Power Input: 655 (W)

Overall efficiency (η): 39.2
Grade efficiency (G): 46.7

dB(A)_LW (Sound Level Power @ Free Air)

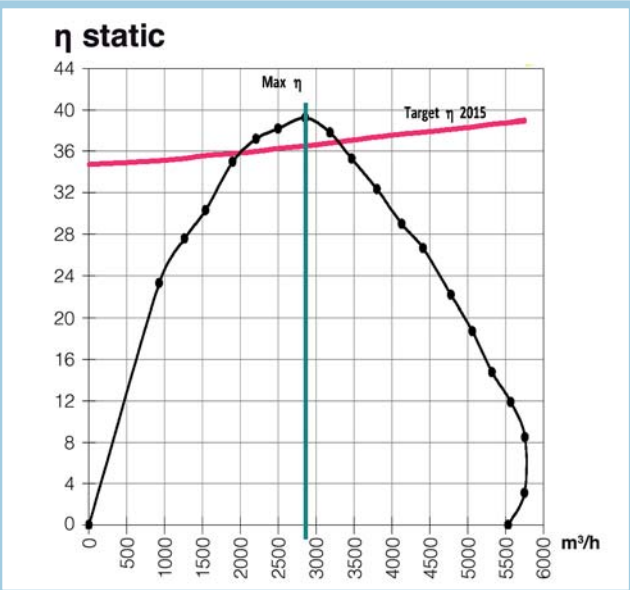
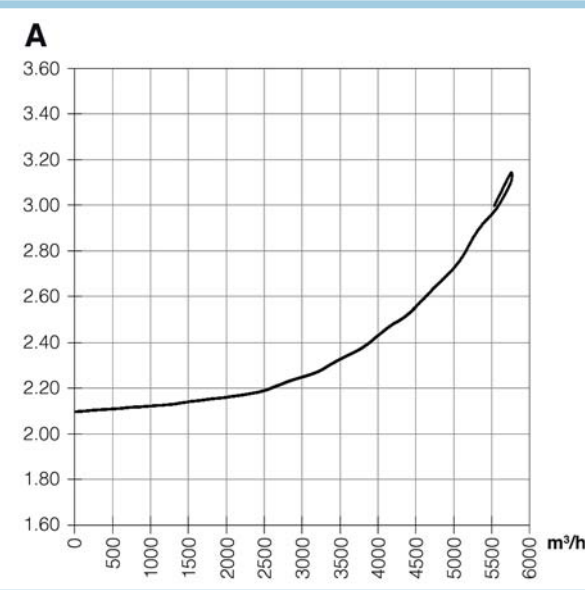
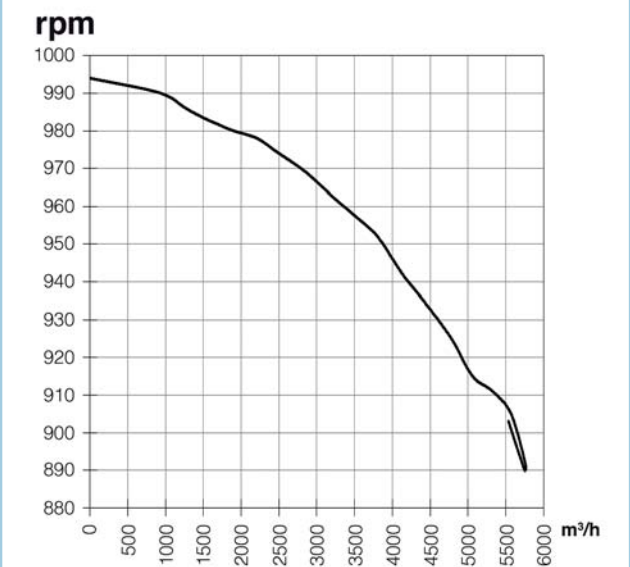
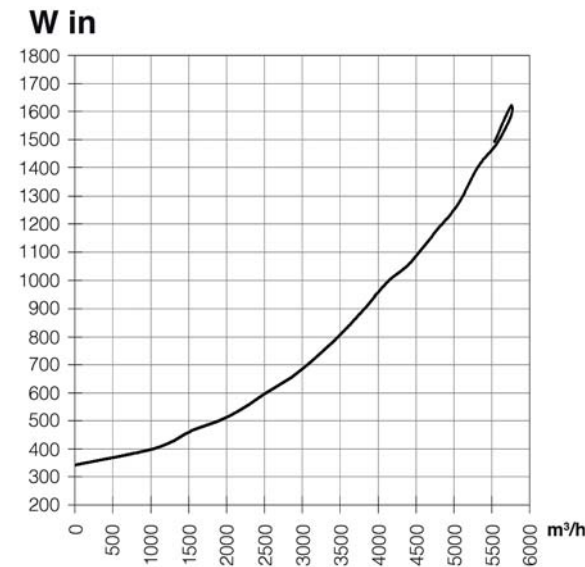
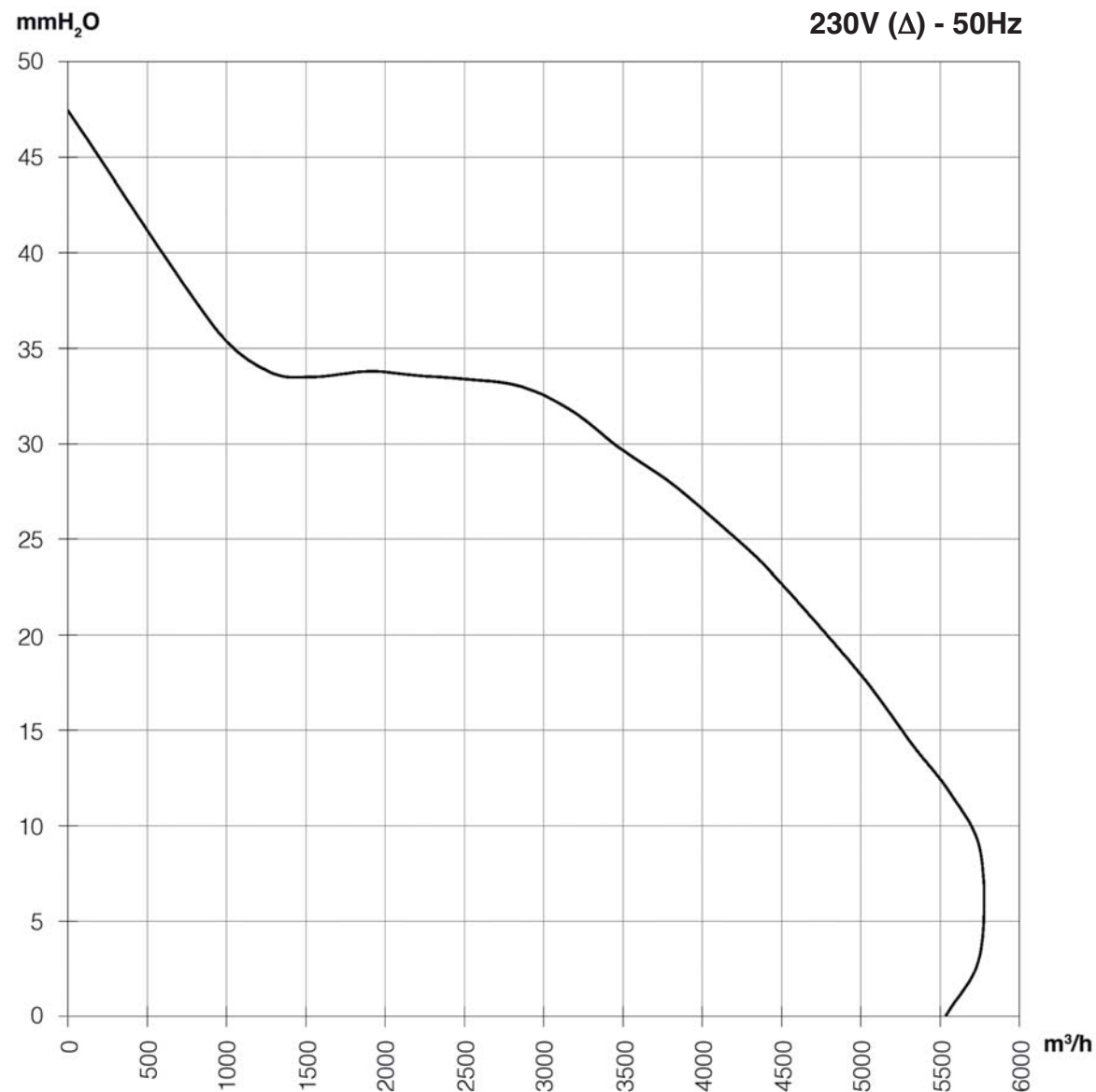
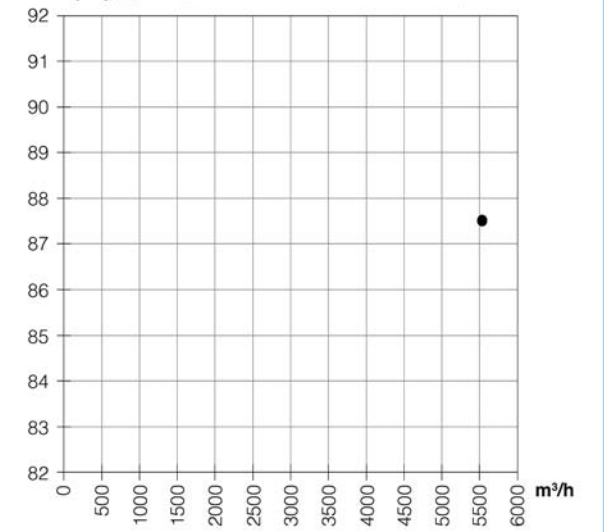



PERFORMANCE CURVES

DD 12/12 - 550-6P-3V 6 Poles

ErP 2015

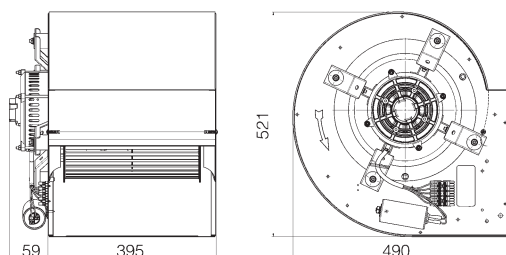

Ventilator Type: DD 12/12

Blowers Material: Metal
Housing Material: Metal
Motor Support Material: Metal

Motor Type: 3 HOM

Power Supply: 1 ~
Nominal Voltage: 230V
Frequency: 50-60 Hz
Nominal Watts: 550
Range Power: 200-254 V
Capacitor: 20 µF

Electrical Insulation Class: Cl.F (155°C)
Protection: Thermally Prot.

Test: PDD-5071 Web: 480

Operating limits Max Speed 50 Hz (Rating Values)

Win: Max 1250 (W)
Ampere: Max 5.5 (A)
Static Pressure: Min 10 - Max 35 (mmH₂O)

Measurement Category - A -

Free Inlet - Free Outlet

Value @ max. efficiency (Max Speed 50 Hz)

Air Flow: 3323 (m³/h)
Static Pressure: 29.3 (mmH₂O)
Rpm: 920 (min⁻¹)
Power Input: 710 (W)

Overall efficiency (η): 37.3

Grade efficiency (G): 44.5

dB(A)_LW (Sound Level Power @ Free Air)

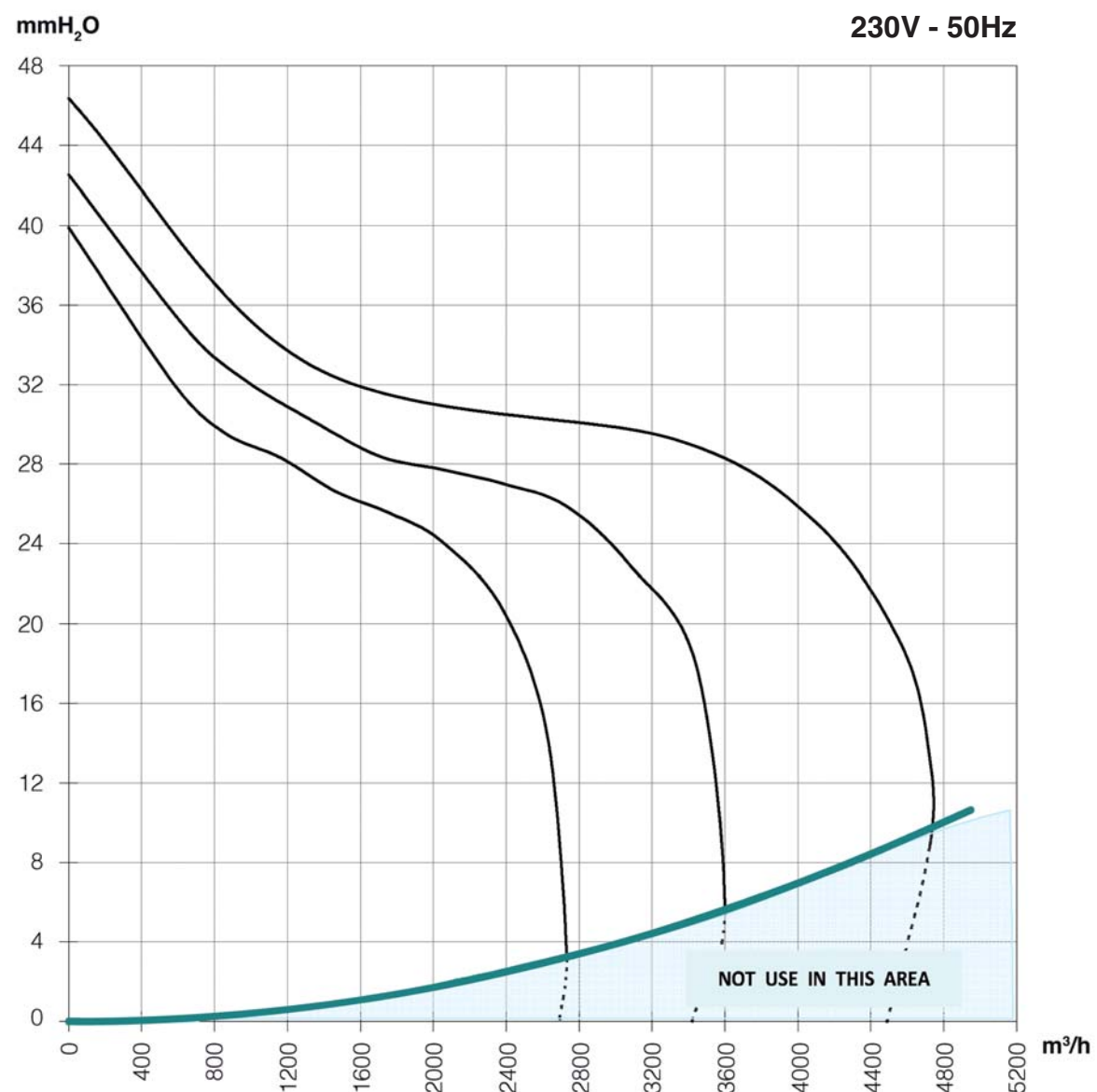
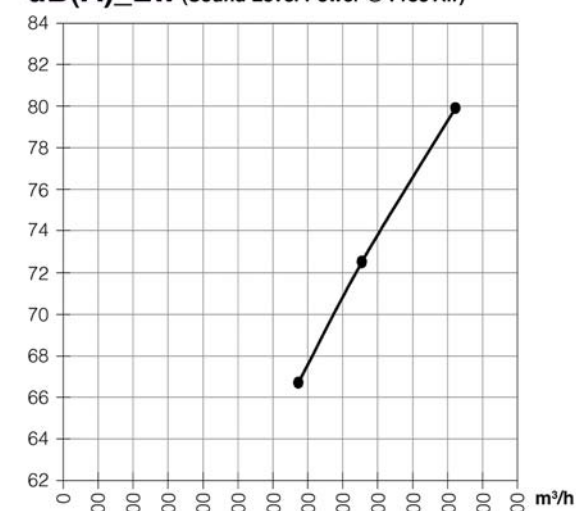

W in

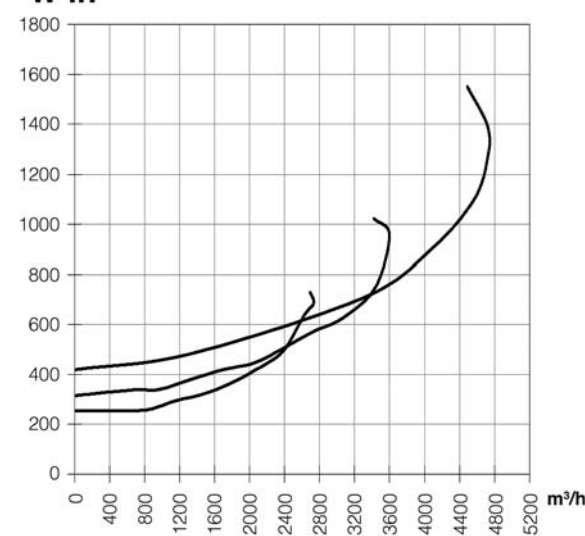

rpm

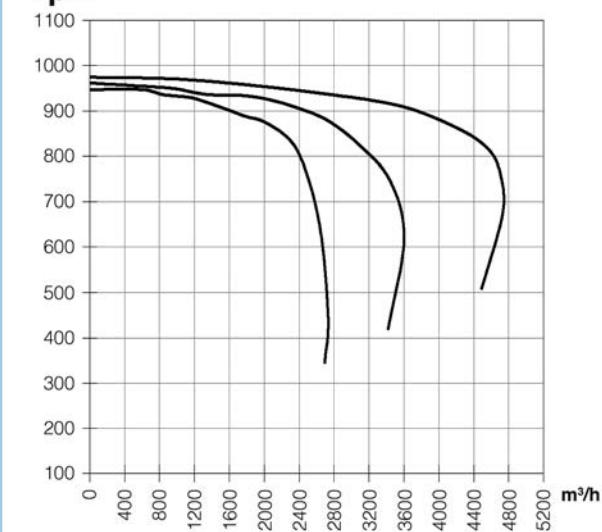

A

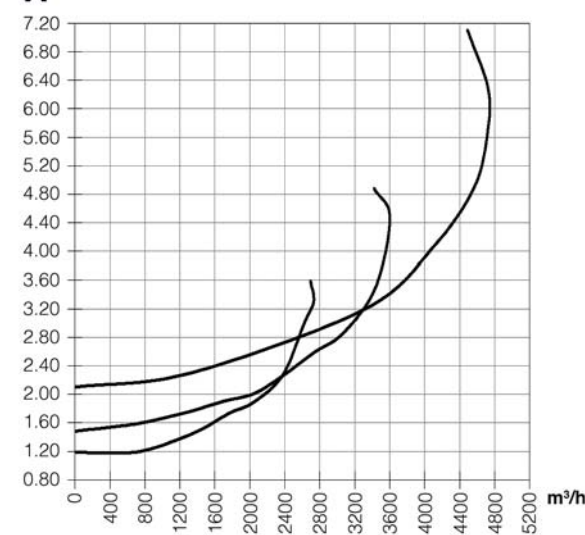

η static

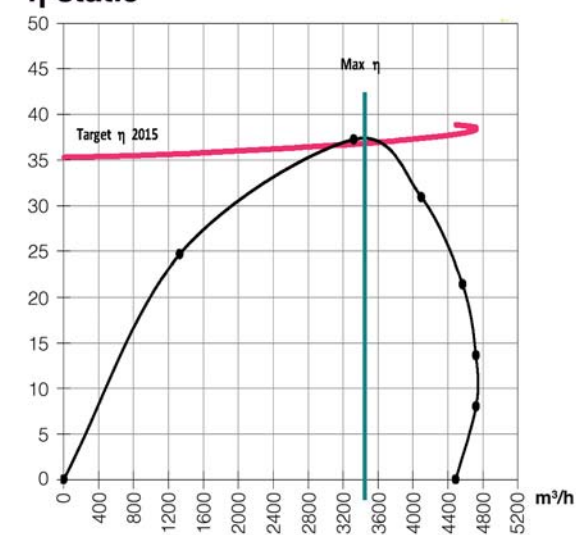



PERFORMANCE CURVES

DD 12/12 - 735-6P-3V 6 Poles

ErP 2015

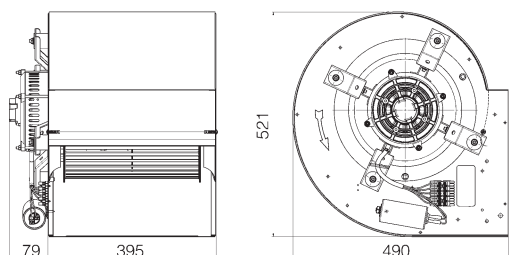

Ventilator Type: DD 12/12

Blowers Material: Metal
Housing Material: Metal
Motor Support Material: Metal

Motor Type: 3 HOM

Power Supply: 1 ~
Nominal Voltage: 230V
Frequency: 50-60 Hz
Nominal Watts: 735
Range Power: 200-254 V
Capacitor: 20 µF

Electrical Insulation Class: Cl.F (155°C)
Protection: Thermally Prot.

Test: PDD-5006 Web: 386

Operating limits Max Speed 50 Hz (Rating Values)

Win: Max 1400 (W)
Ampere: Max 6.0 (A)
Static Pressure: Min 10 - Max 40 (mmH₂O)

Measurement Category - A -

Free Inlet - Free Outlet

Value @ max. efficiency (Min Speed 50 Hz)

Air Flow: 2018 (m³/h)
Static Pressure: 29.3 (mmH₂O)
Rpm: 949 (min⁻¹)
Power Input: 406 (W)

Overall efficiency (η): 39.6

Grade efficiency (G): 48.4

dB(A)_LW (Sound Level Power @ Free Air)

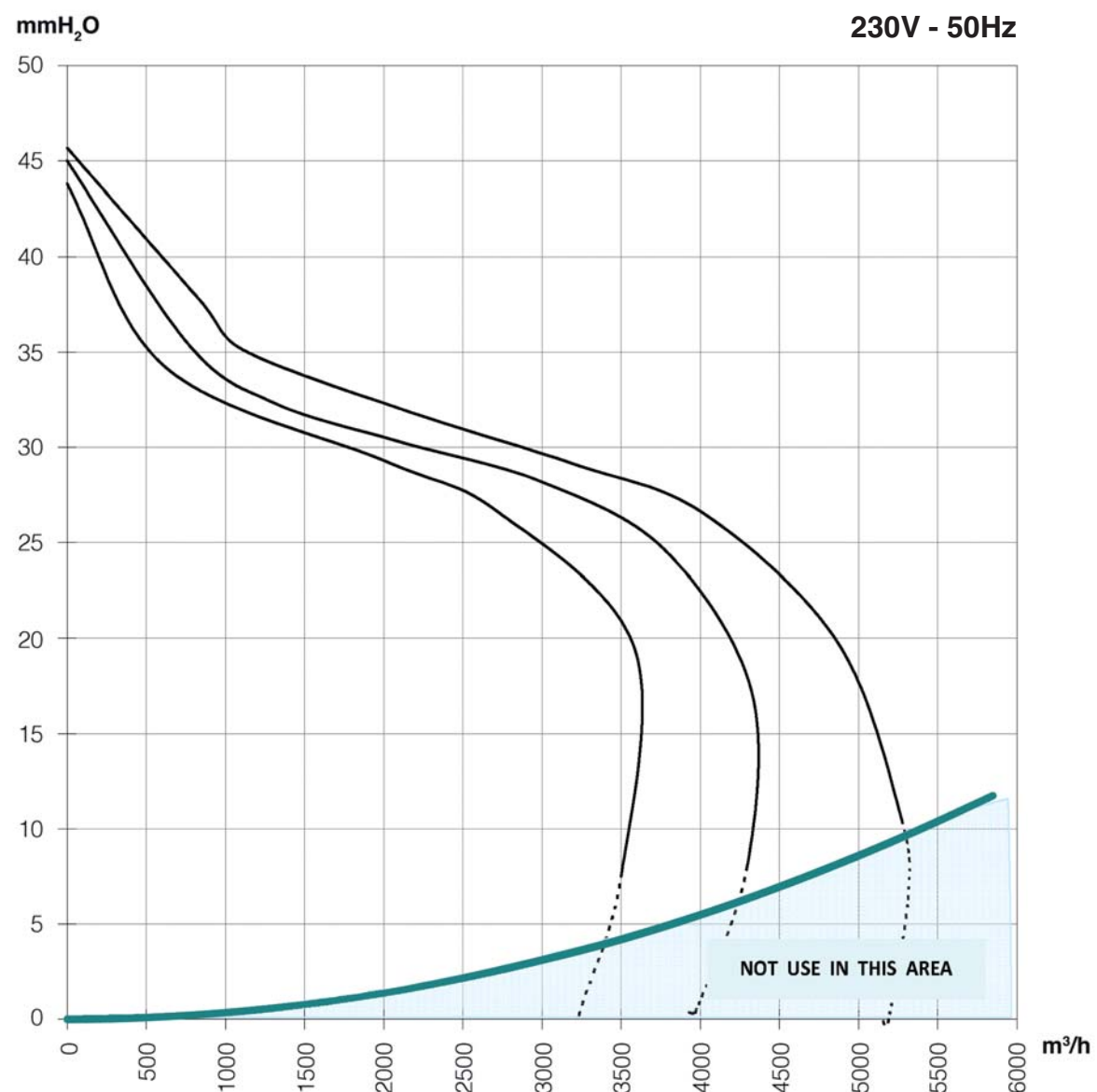
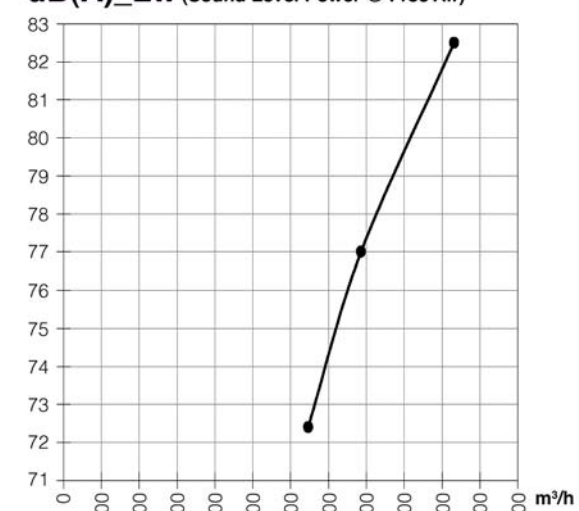

W in

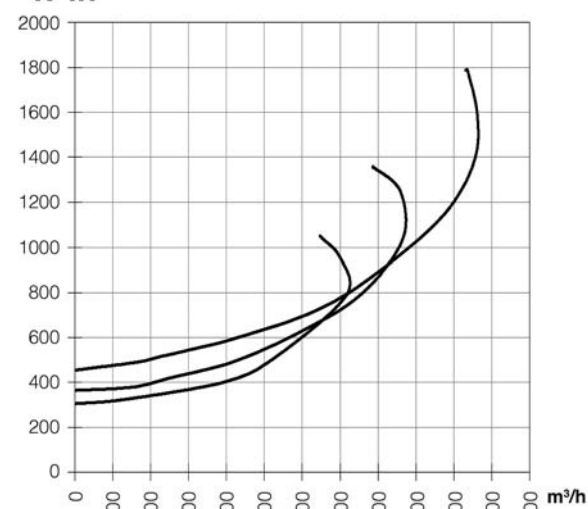

rpm

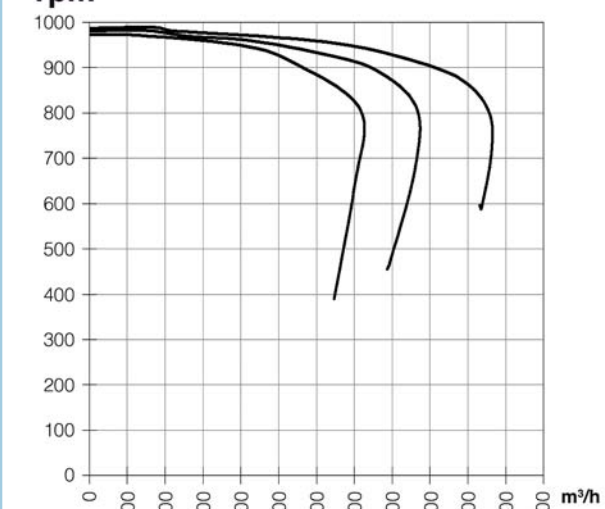

A

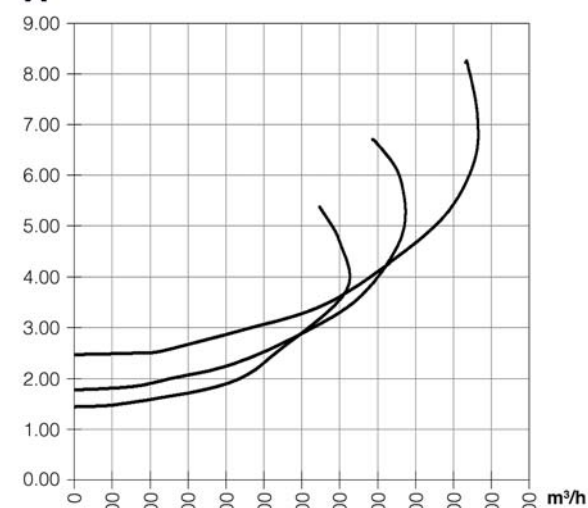

η static

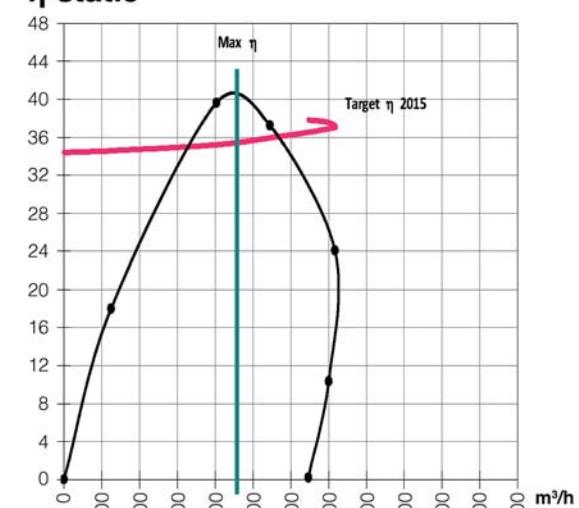



PERFORMANCE CURVES

DD 12/12 - 1100-6P-1V-T 6 Poles

ErP 2015

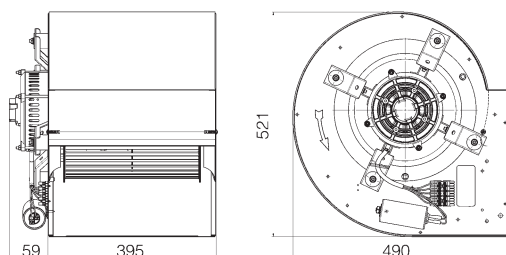

Ventilator Type: DD 12/12
 Blowers Material: Metal
 Housing Material: Metal
 Motor Support Material: Metal

Motor Type: 3 HOM
 Power Supply: 3 ~
 Nominal Voltage: 230V (Δ) - 400V (Y)
 Frequency: 50-60 Hz
 Nominal Watts: 1100

Range Power: 200-254 V (Δ)
 360-440 V (Y)

Electrical Insulation Class: Cl.F (155°C)
 Protection: Thermally Prot.

Test: PDD-5004 Web: 385

Operating limits Max Speed 50 Hz (Rating Values)

Win: Max 2100 (W)
 Ampere: Max 3.5 A (Δ) - 6.0 A (Y)
 Static Pressure: Min 0 - Max 44 (mmH₂O)

Measurement Category - A - Free Inlet - Free Outlet

Value @ max. efficiency (50 Hz)
 Air Flow: 3461 (m³/h)
 Static Pressure: 30.6 (mmH₂O)
 Rpm: 958 (min⁻¹)
 Power Input: 748 (W)

Overall efficiency (η): 38.6
 Grade efficiency (G): 45.7

dB(A)_LW (Sound Level Power @ Free Air)

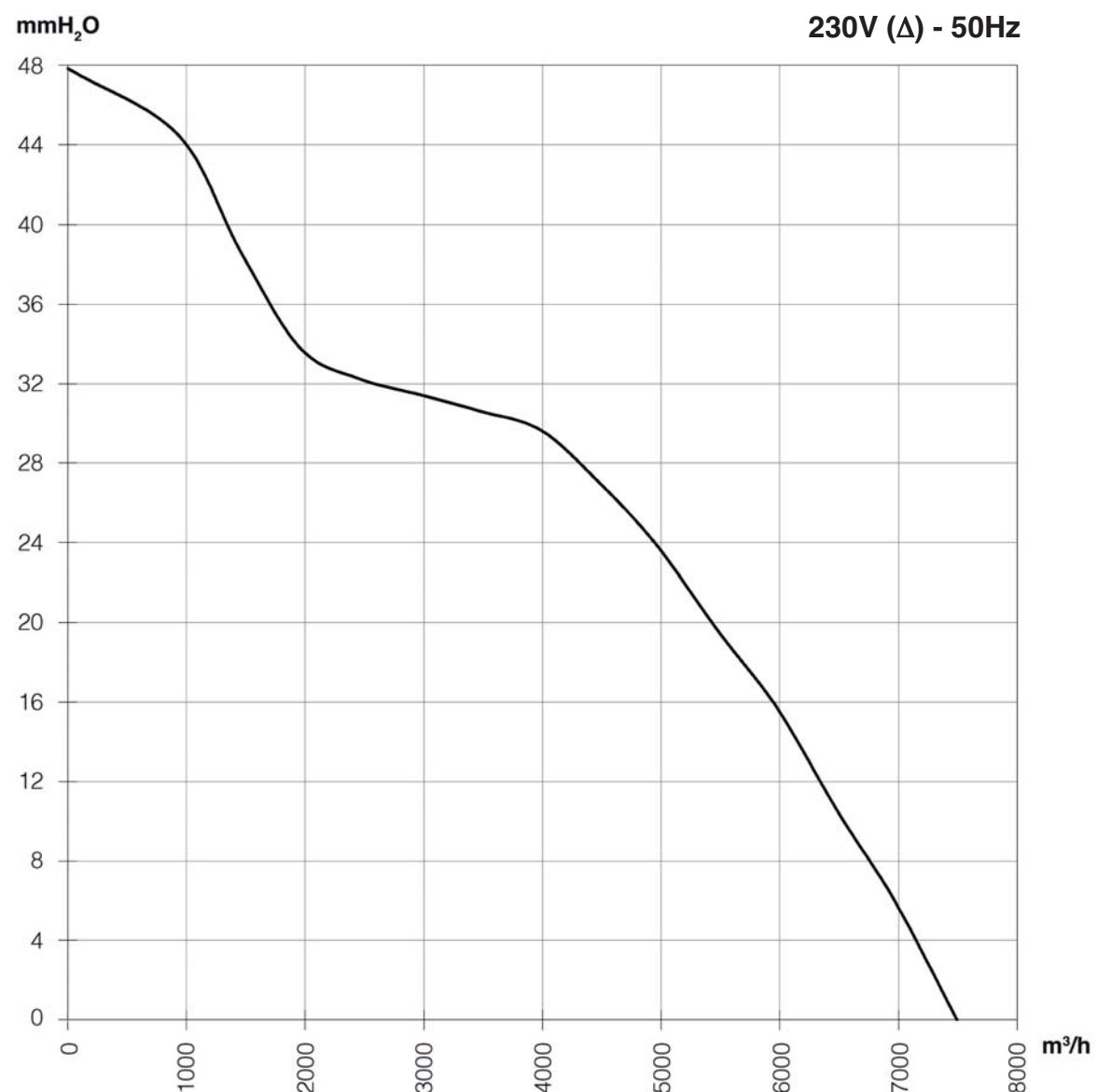
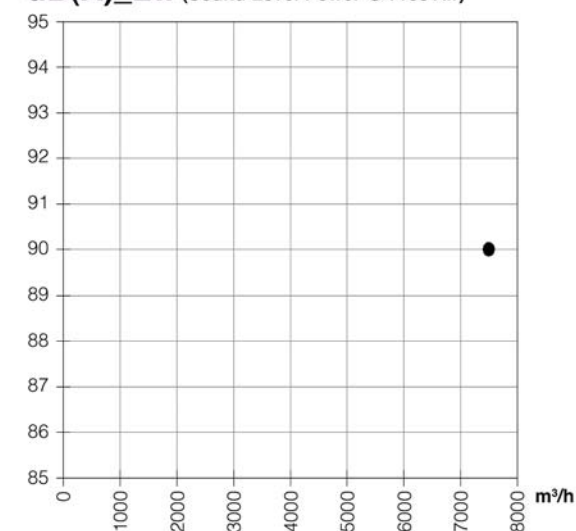

W in

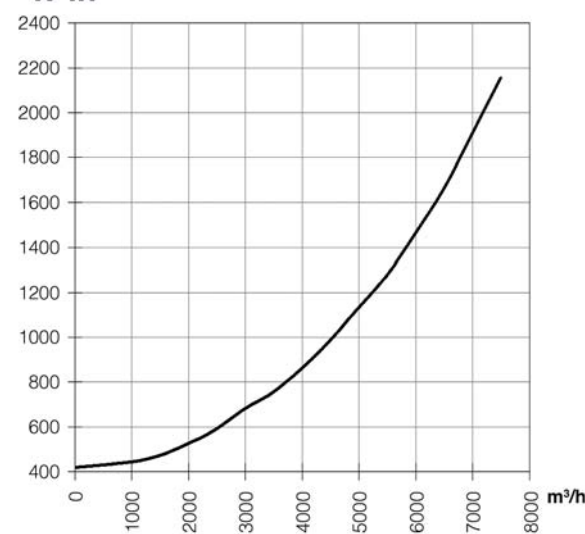

rpm

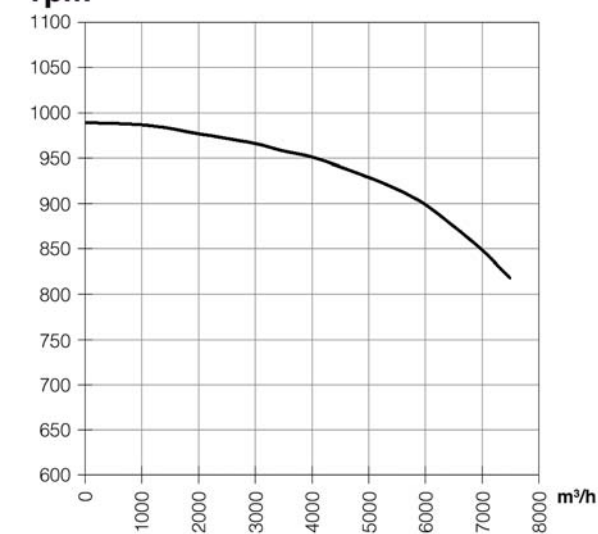

A

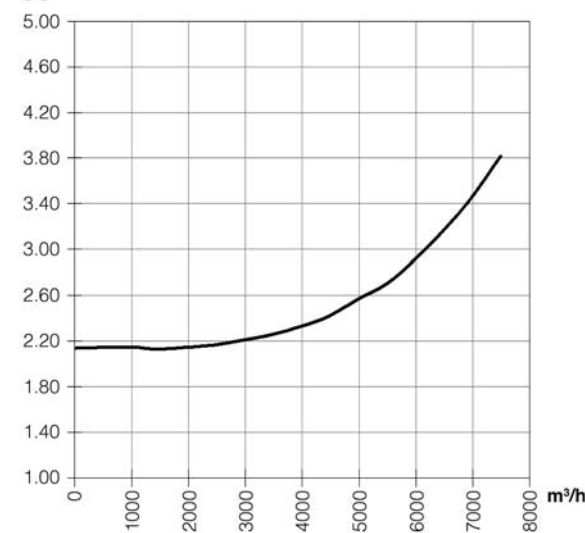

η static

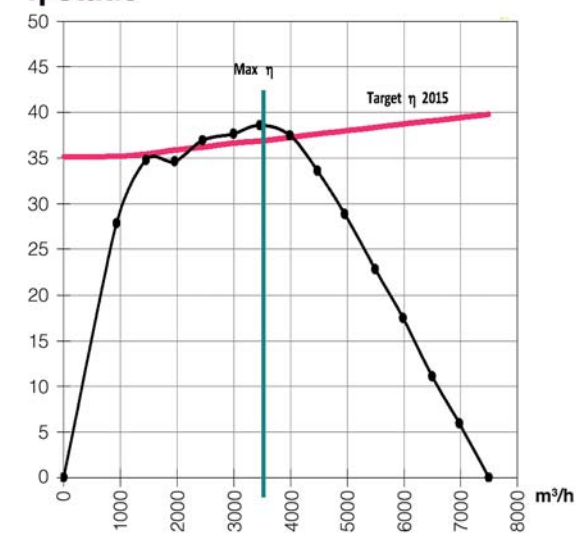



PERFORMANCE CURVES

DD 7/7 - 145-4P-3V 4 Poles

ErP 2015

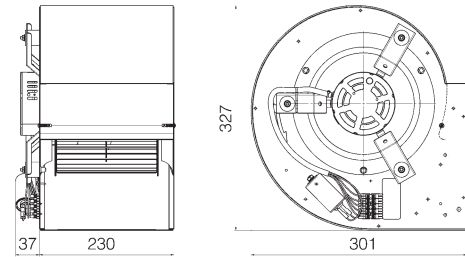

Ventilator Type: DD 7/7
Blowers Material: Metal
Housing Material: Metal
Motor Support Material: Metal

Motor Type: 3 FGM
Power Supply: 1 ~
Nominal Voltage: 230V
Frequency: 50-60 Hz
Nominal Watts: 145
Range Power: 200-254 V
Capacitor: 5 µF

Electrical Insulation Class: Cl.F (155°C)
Protection: Thermally Prot.

Test: PDD-5044 Web: 346

Operating limits Max Speed 50 Hz (Rating Values)
Win: Max 450 (W)
Ampere: Max 2.1 (A)
Static Pressure: Min 0 - Max 35 (mmH₂O)

Measurement Category - A -
Free Inlet - Free Outlet

Value @ max. efficiency (Max Speed 50 Hz)
Air Flow: 1112 (m³/h)
Static Pressure: 25.8 (mmH₂O)
Rpm: 1390 (min⁻¹)
Power Input: 231 (W)

Overall efficiency (η): 33.8
Grade efficiency (G): 44.1

dB(A)_LW (Sound Level Power @ Free Air)

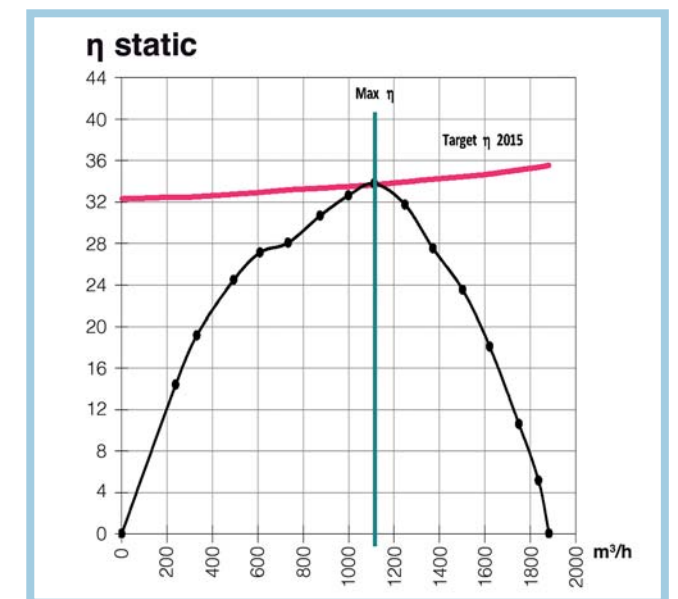
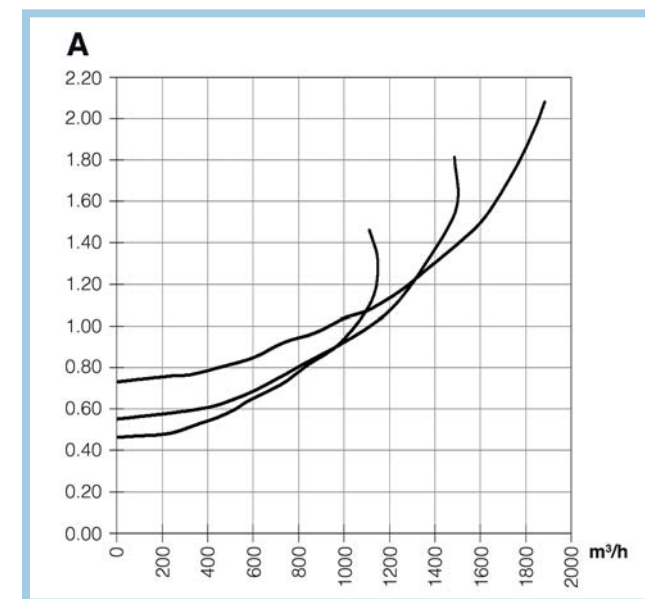
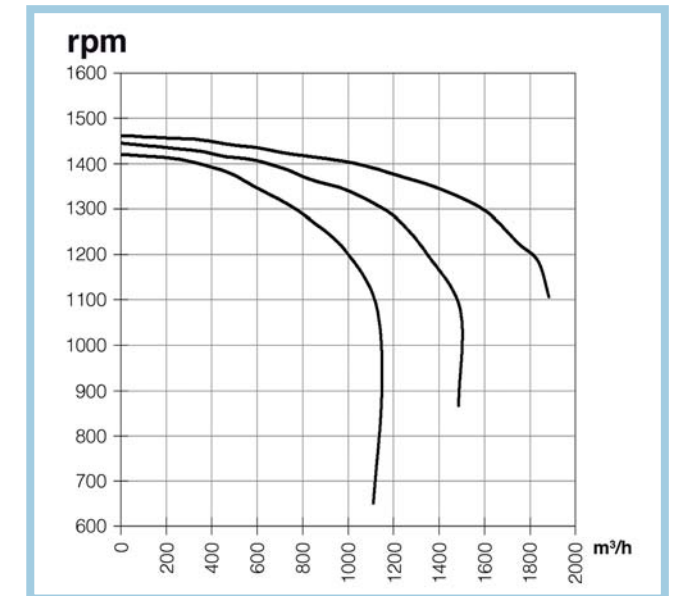
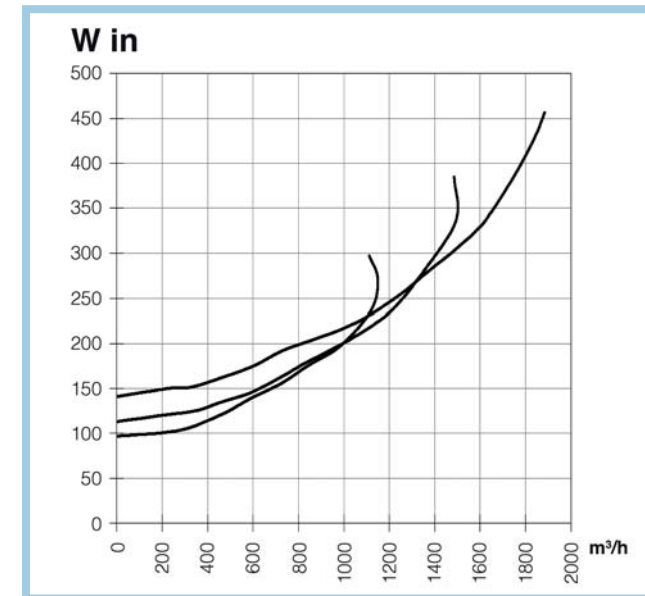
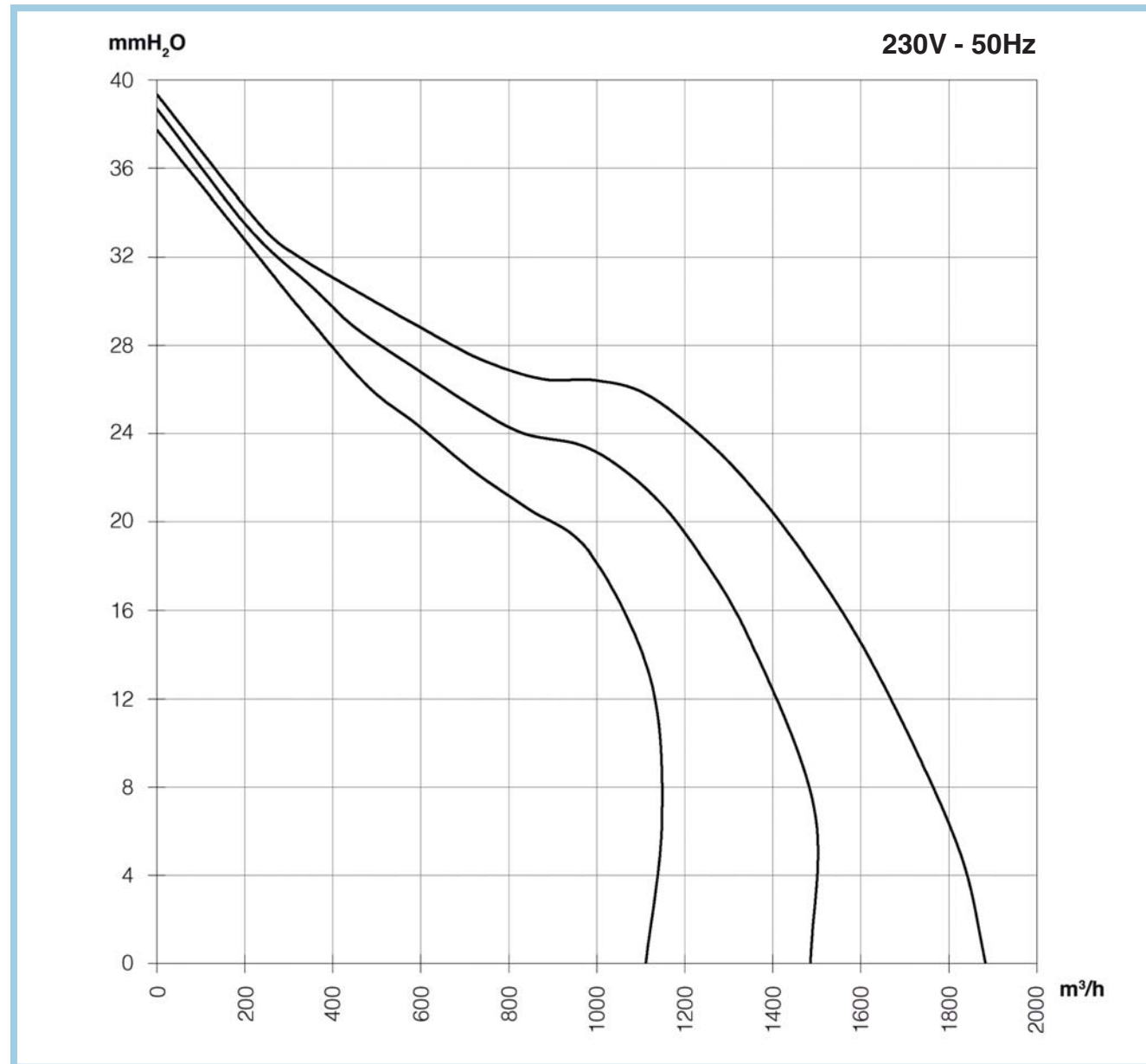
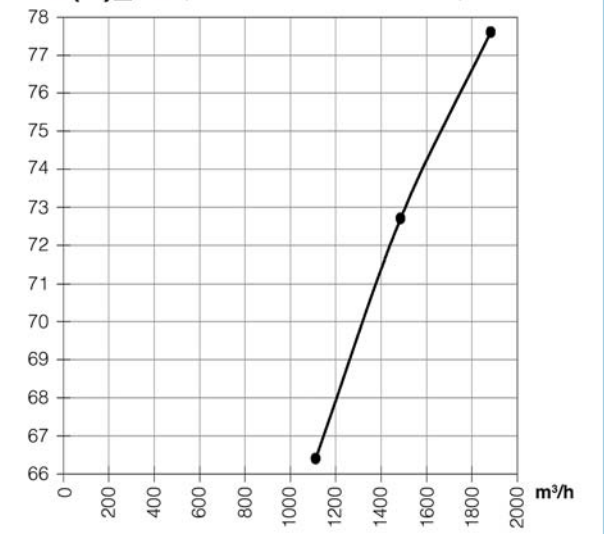



PERFORMANCE CURVES

DD 9/9 T - 300-4P-3V 4 Poles

ErP 2015

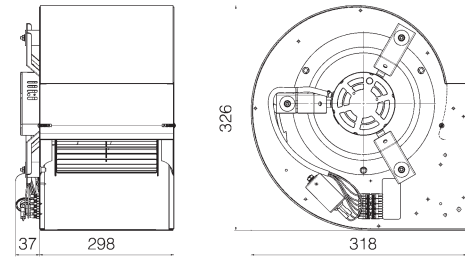

Ventilator Type: DD 9/9 T
 Blowers Material: Metal
 Housing Material: Metal
 Motor Support Material: Metal

Motor Type: 3 FGM
 Power Supply: 1 ~
 Nominal Voltage: 230V
 Frequency: 50-60 Hz
 Nominal Watts: 300
 Range Power: 200-254 V
 Capacitor: 6.3 μF

Electrical Insulation Class: Cl.F (155°C)
 Protection: Thermally Prot.

Test: PDD-5056 Web: 354

Operating limits Max Speed 50 Hz (Rating Values)
 Win: Max 720 (W)
 Ampere: Max 3.5 (A)
 Static Pressure: Min 0 - Max 40 (mmH₂O)

Measurement Category - A -
Free Inlet - Free Outlet

Value @ max. efficiency (Max Speed 50 Hz)
 Air Flow: 1399 (m³/h)
 Static Pressure: 29.7 (mmH₂O)
 Rpm: 1349 (min⁻¹)
 Power Input: 326 (W)

Overall efficiency (η): 34.6
Grade efficiency (G): 44.0

dB(A)_LW (Sound Level Power @ Free Air)

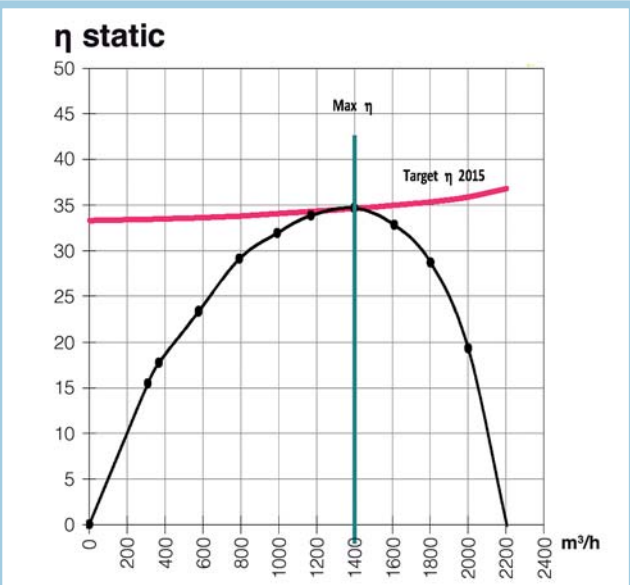
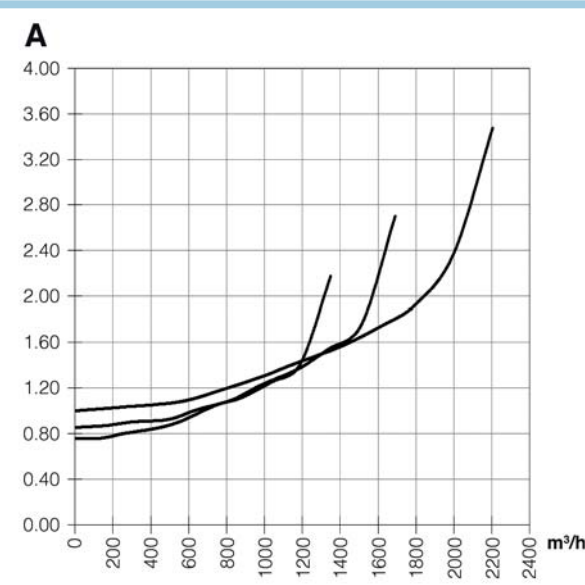
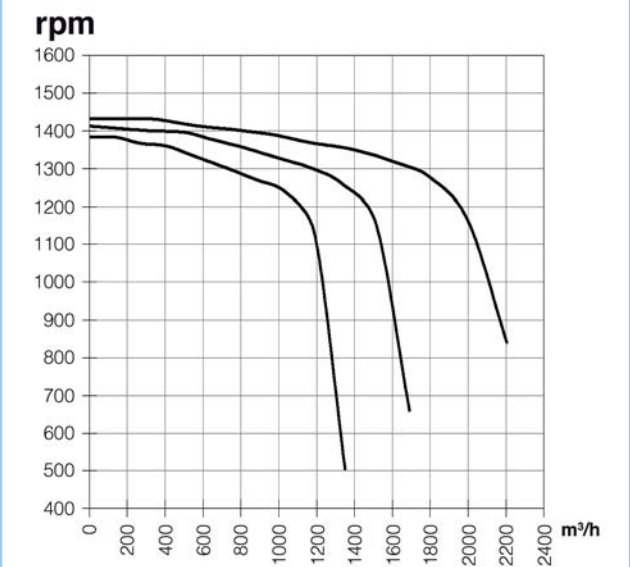
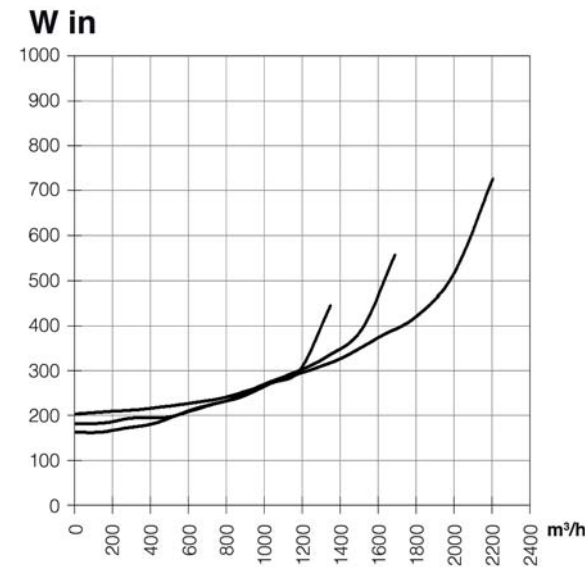
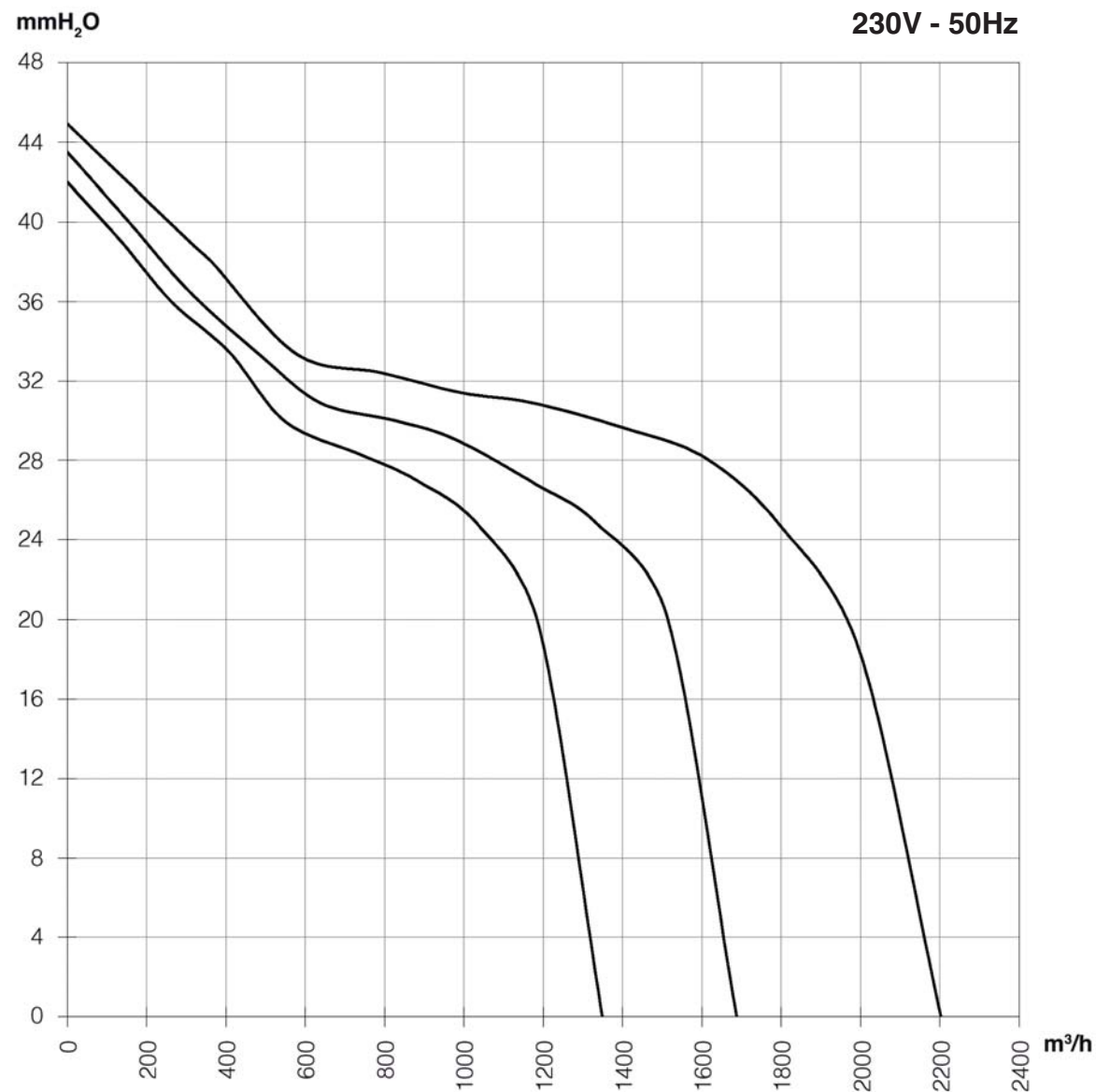
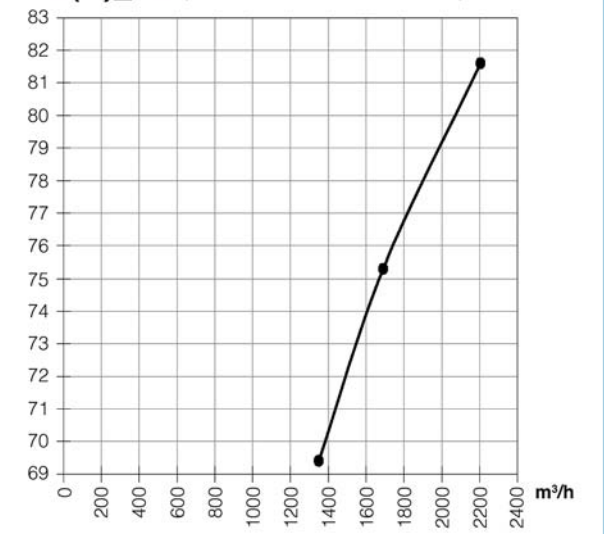



PERFORMANCE CURVES

DD 9/7 - 370-4P-3V 4 Poles

ErP 2015

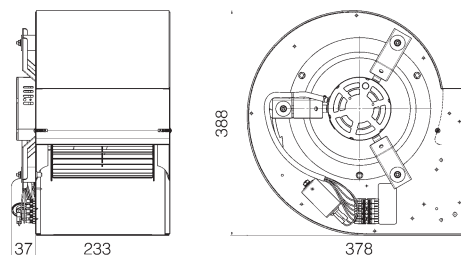

Ventilator Type: DD 9/7
 Blowers Material: Metal
 Housing Material: Metal
 Motor Support Material: Metal

Motor Type: 3 FGM
 Power Supply: 1 ~
 Nominal Voltage: 230V
 Frequency: 50-60 Hz
 Nominal Watts: 370
 Range Power: 200-254 V
 Capacitor: 12.5 μ F

Electrical Insulation Class: Cl.F (155°C)
 Protection: Thermally Prot.

Test: PDD-5031 Web: 347

Operating limits Max Speed 50 Hz (Rating Values)

Win: Max 920 (W)
 Ampere: Max 4.2 (A)
 Static Pressure: Min 0 - Max 40 (mmH₂O)

Measurement Category - A - Free Inlet - Free Outlet

Value @ max. efficiency (Max Speed 50 Hz)

Air Flow: 1758 (m³/h)
 Static Pressure: 34.0 (mmH₂O)
 Rpm: 1345 (min⁻¹)
 Power Input: 457 (W)

Overall efficiency (η): 35.6
 Grade efficiency (G): 44.1

dB(A)_LW (Sound Level Power @ Free Air)

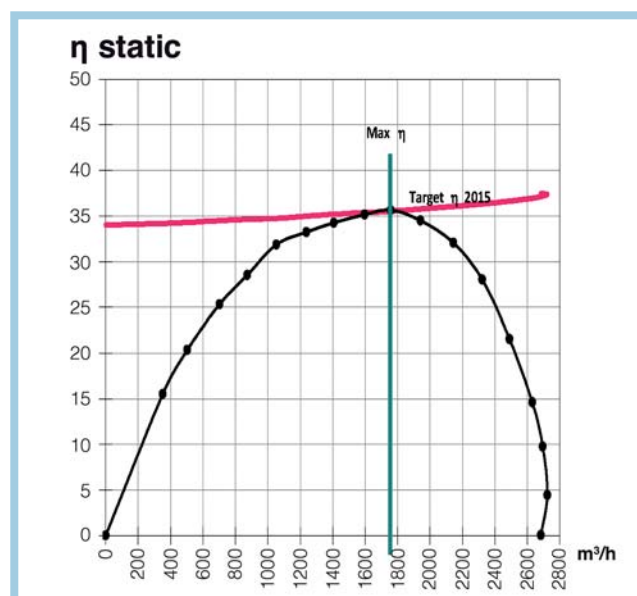
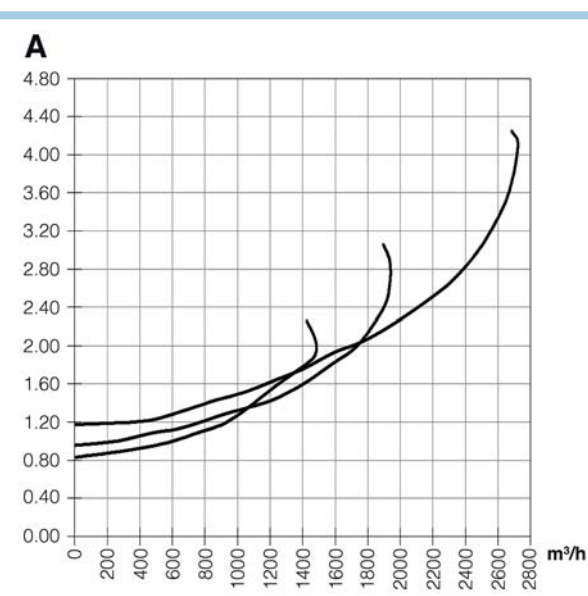
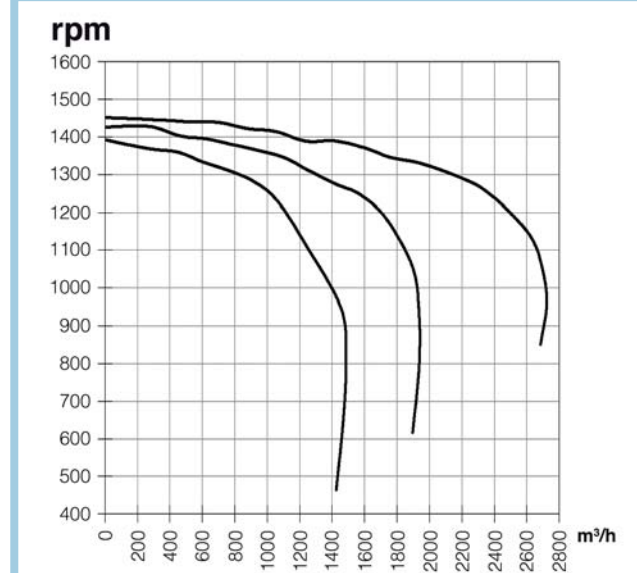
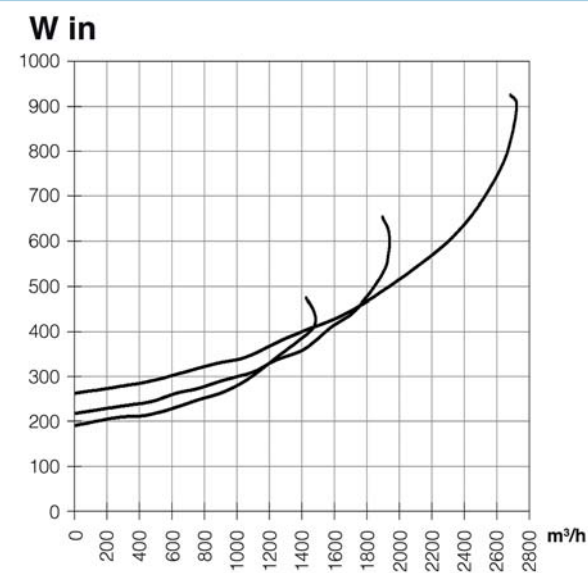
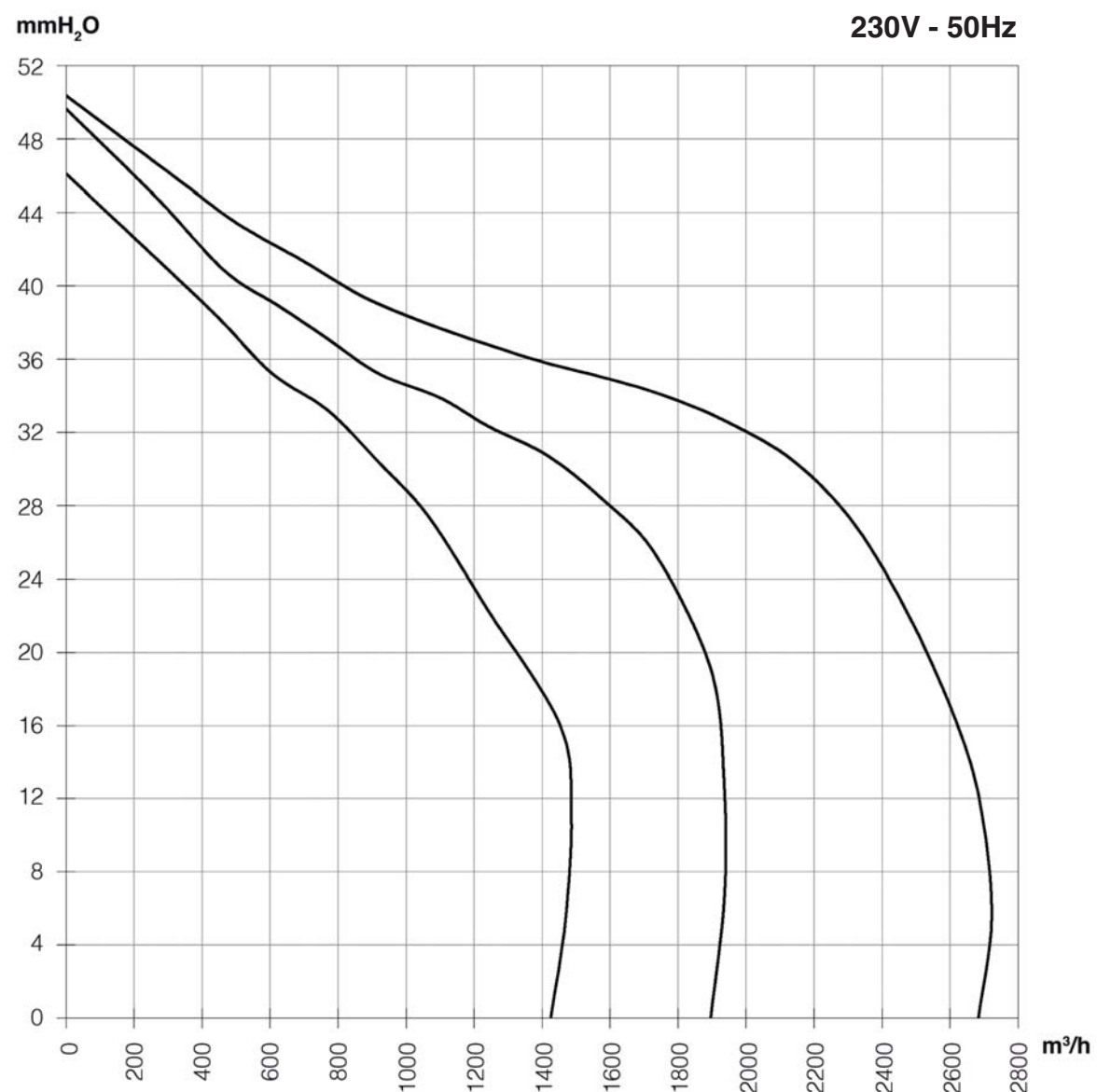
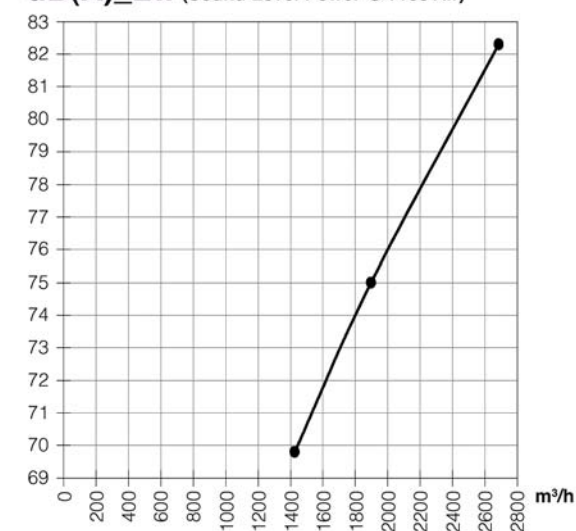



PERFORMANCE CURVES

DD 9/9 - 370-4P-3V 4 Poles

ErP 2015

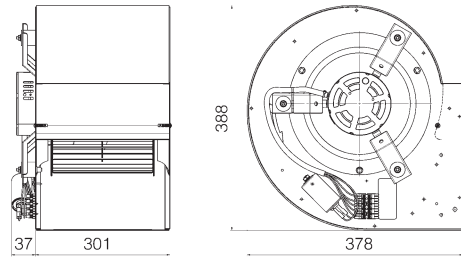

Ventilator Type: DD 9/9
 Blowers Material: Metal
 Housing Material: Metal
 Motor Support Material: Metal

Motor Type: 3 FGM
 Power Supply: 1 ~
 Nominal Voltage: 230V
 Frequency: 50-60 Hz
 Nominal Watts: 370
 Range Power: 200-254 V
 Capacitor: 12.5 µF

Electrical Insulation Class: Cl.F (155°C)
 Protection: Thermally Prot.

Test: PDD-5030 Web: 348

Operating limits Max Speed 50 Hz (Rating Values)
 Win: Max 920 (W)
 Ampere: Max 4.2 (A)
 Static Pressure: Min 0 - Max 50 (mmH₂O)

Measurement Category - A -
Free Inlet - Free Outlet

Value @ max. efficiency (Max Speed 50 Hz)
 Air Flow: 1664 (m³/h)
 Static Pressure: 36.1 (mmH₂O)
 Rpm: 1351 (min⁻¹)
 Power Input: 456 (W)

Overall efficiency (η): 35.9
Grade efficiency (G): 44.4

dB(A)_LW (Sound Level Power @ Free Air)

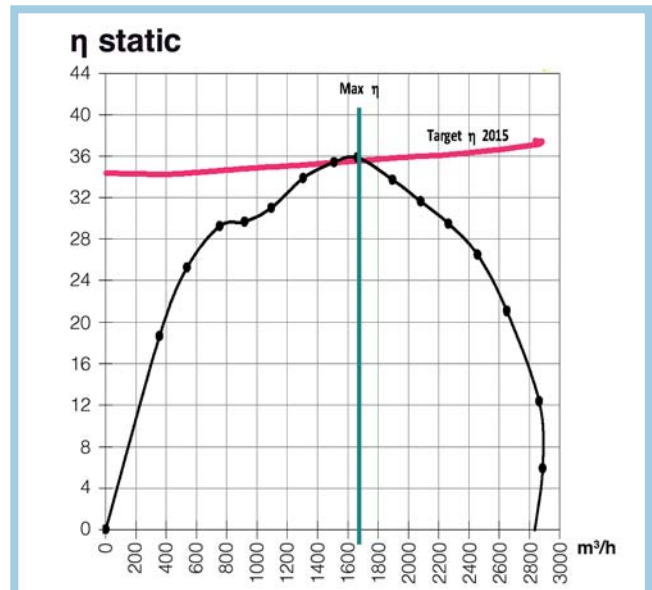
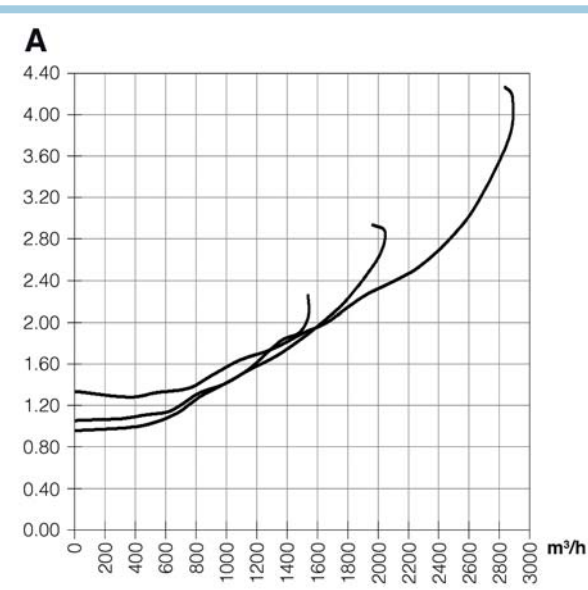
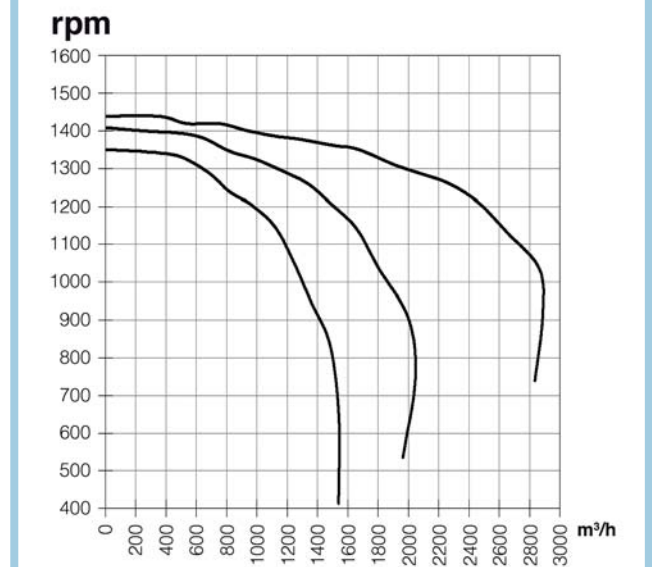
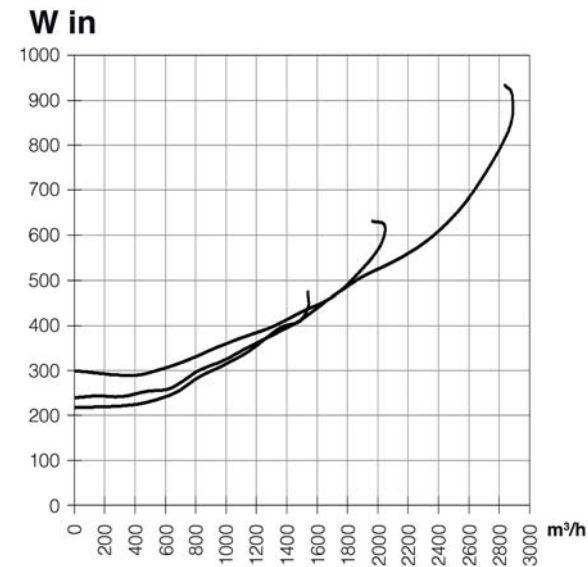
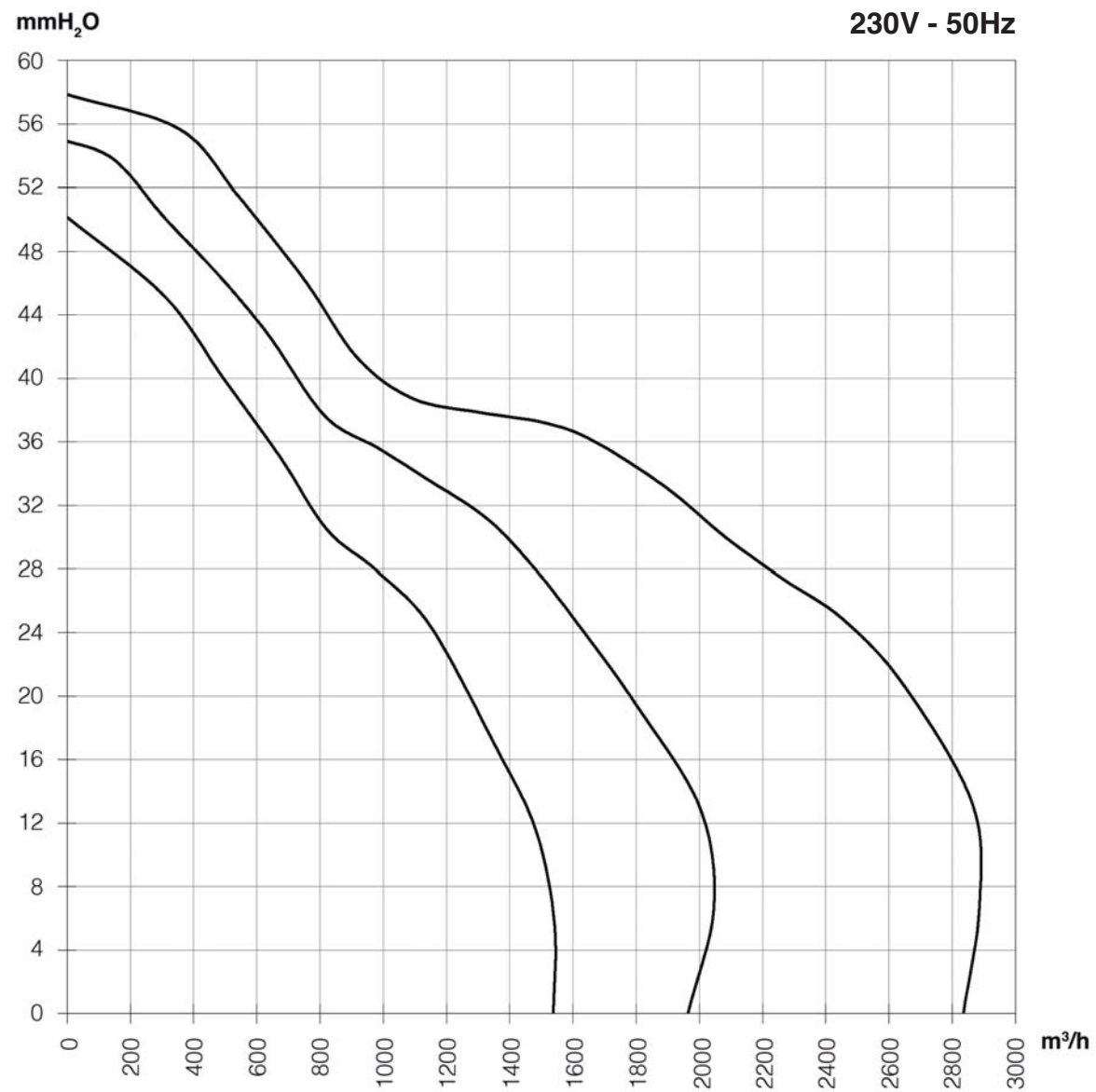
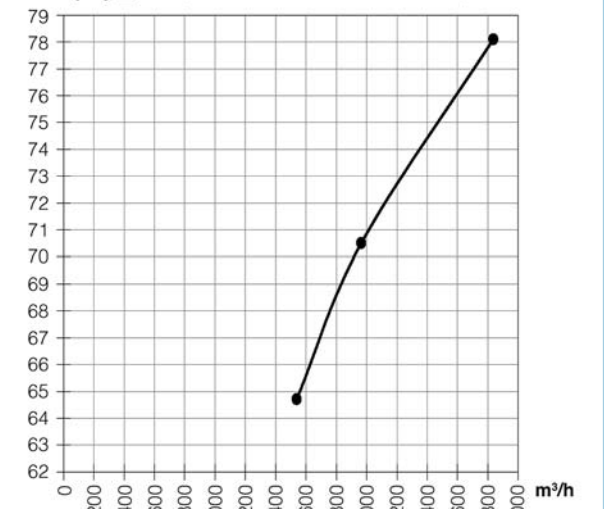



PERFORMANCE CURVES

DD 9/9 - 550-4P-3V 4 Poles

ErP 2015

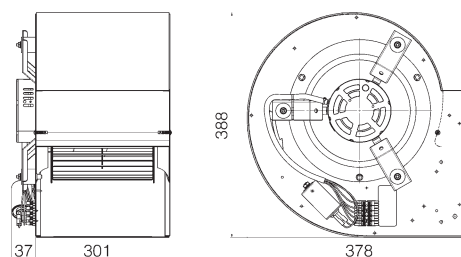

Ventilator Type: DD 9/9

Blowers Material: Metal
Housing Material: Metal
Motor Support Material: Metal

Motor Type: 3 FGM

Power Supply: 1 ~
Nominal Voltage: 230V
Frequency: 50-60 Hz
Nominal Watts: 550
Range Power: 200-254 V
Capacitor: 12.5 μ F

Electrical Insulation Class: Cl.F (155°C)
Protection: Thermally Prot.

Test: PDD-5046 Web: 349

Operating limits Max Speed 50 Hz (Rating Values)

Win: Max 1100 (W)
Ampere: Max 4.5 (A)
Static Pressure: Min 0 - Max 48 (mmH₂O)

Measurement Category - A -

Free Inlet - Free Outlet

Value @ max. efficiency (Max Speed 50 Hz)

Air Flow: 1781 (m³/h)
Static Pressure: 39.2 (mmH₂O)
Rpm: 1339 (min⁻¹)
Power Input: 529 (W)

Overall efficiency (η): 35.9

Grade efficiency (G): 44.0

dB(A)_LW (Sound Level Power @ Free Air)

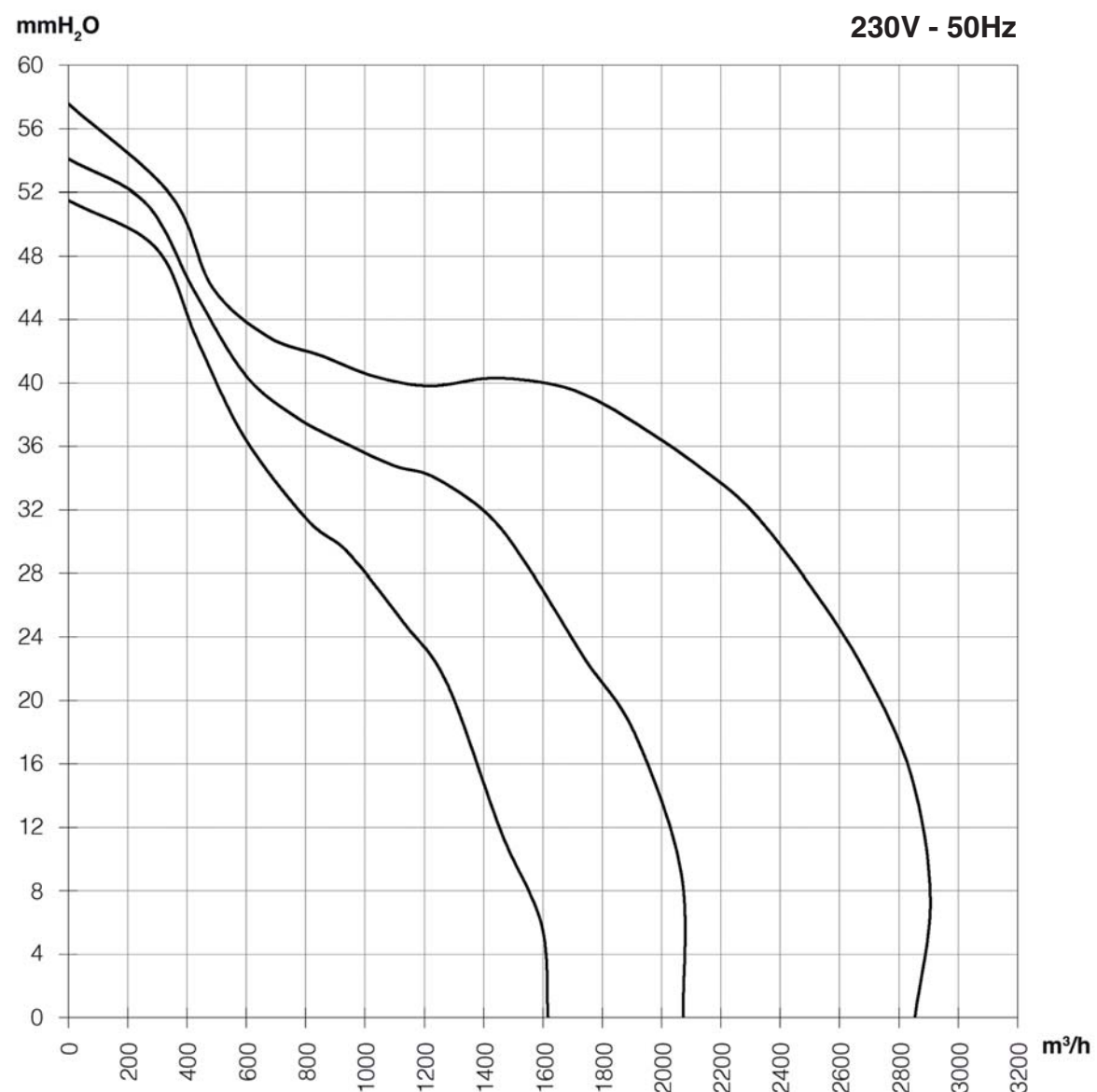
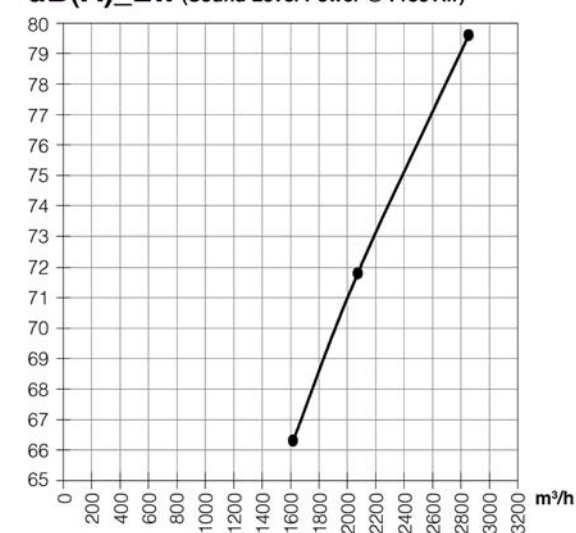

W in

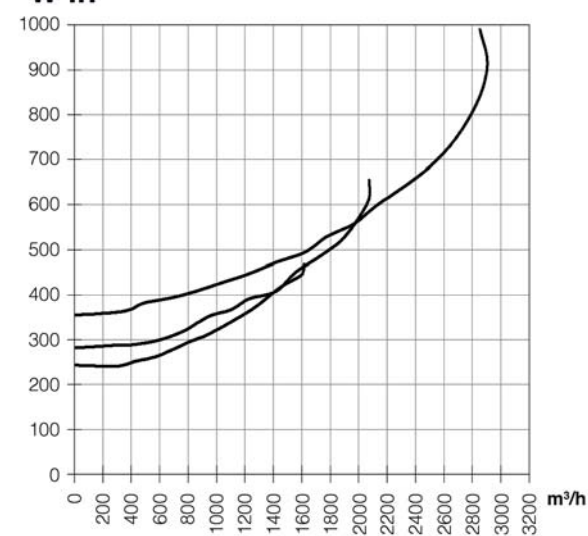

rpm

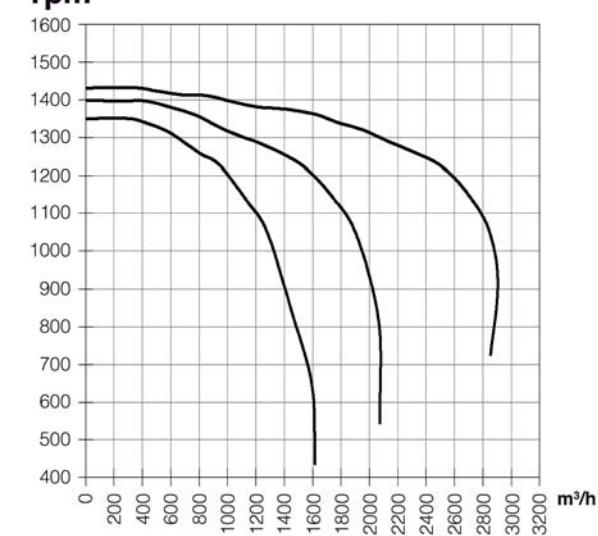

A

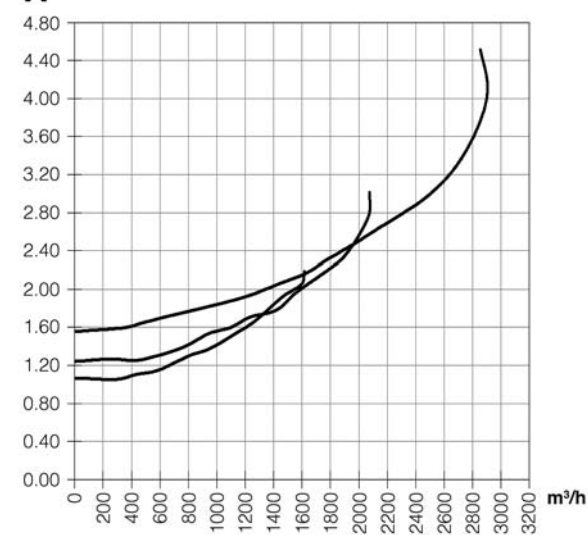

η static

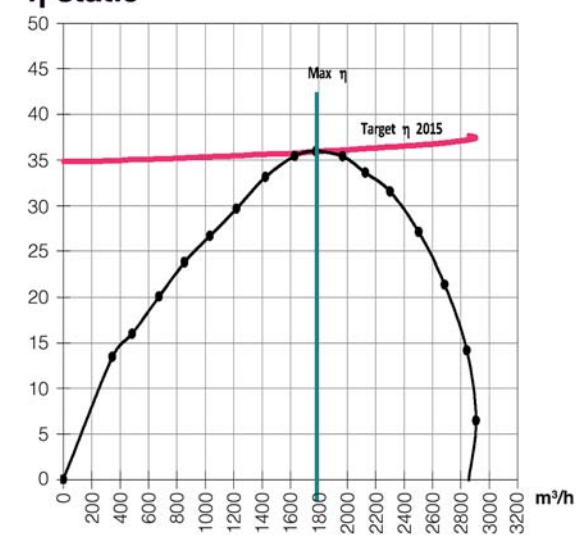



PERFORMANCE CURVES

DD 10/8 - 370-4P-3V 4 Poles

ErP 2015

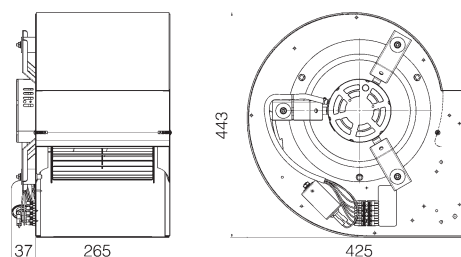

Ventilator Type: DD 10/8
 Blowers Material: Metal
 Housing Material: Metal
 Motor Support Material: Metal

Motor Type: 3 FGM
 Power Supply: 1 ~
 Nominal Voltage: 230V
 Frequency: 50-60 Hz
 Nominal Watts: 370
 Range Power: 200-254 V
 Capacitor: 12.5 µF

Electrical Insulation Class: Cl.F (155°C)
 Protection: Thermally Prot.

Test: PDD-5032 Web: 350

Operating limits Max Speed 50 Hz (Rating Values)

Win: Max 900 (W)
 Ampere: Max 4.2 (A)
 Static Pressure: Min 15 - Max 55 (mmH₂O)

Measurement Category - A - Free Inlet - Free Outlet

Value @ max. efficiency (Max Speed 50 Hz)

Air Flow: 1736 (m³/h)
 Static Pressure: 43.5 (mmH₂O)
 Rpm: 1293 (min⁻¹)
 Power Input: 516 (W)

Overall efficiency (η): 39.9
 Grade efficiency (G): 48.0

dB(A)_LW (Sound Level Power @ Free Air)

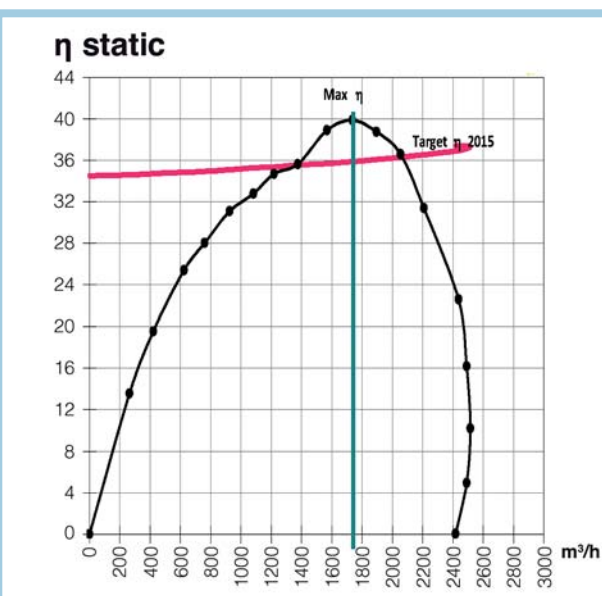
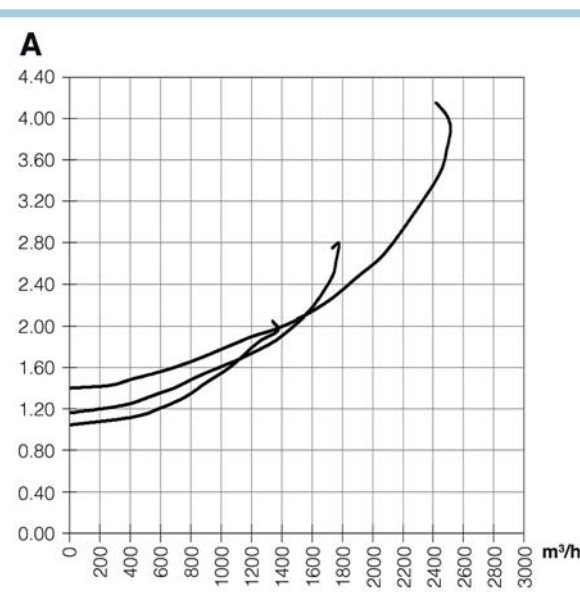
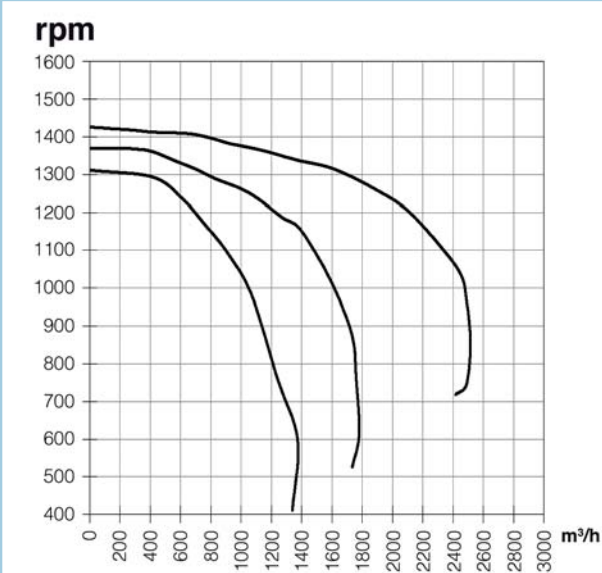
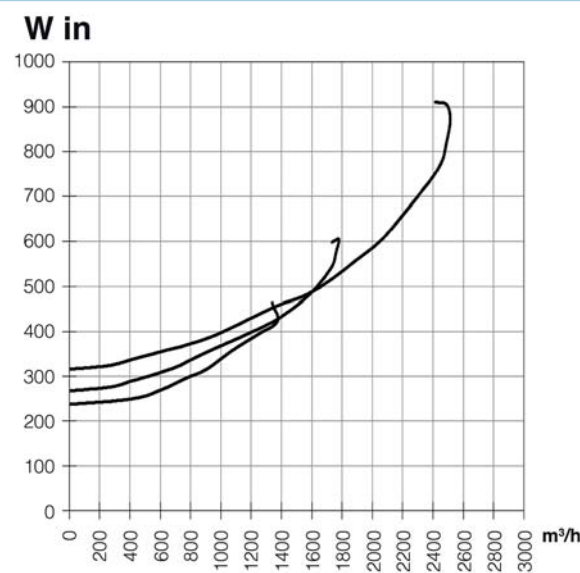
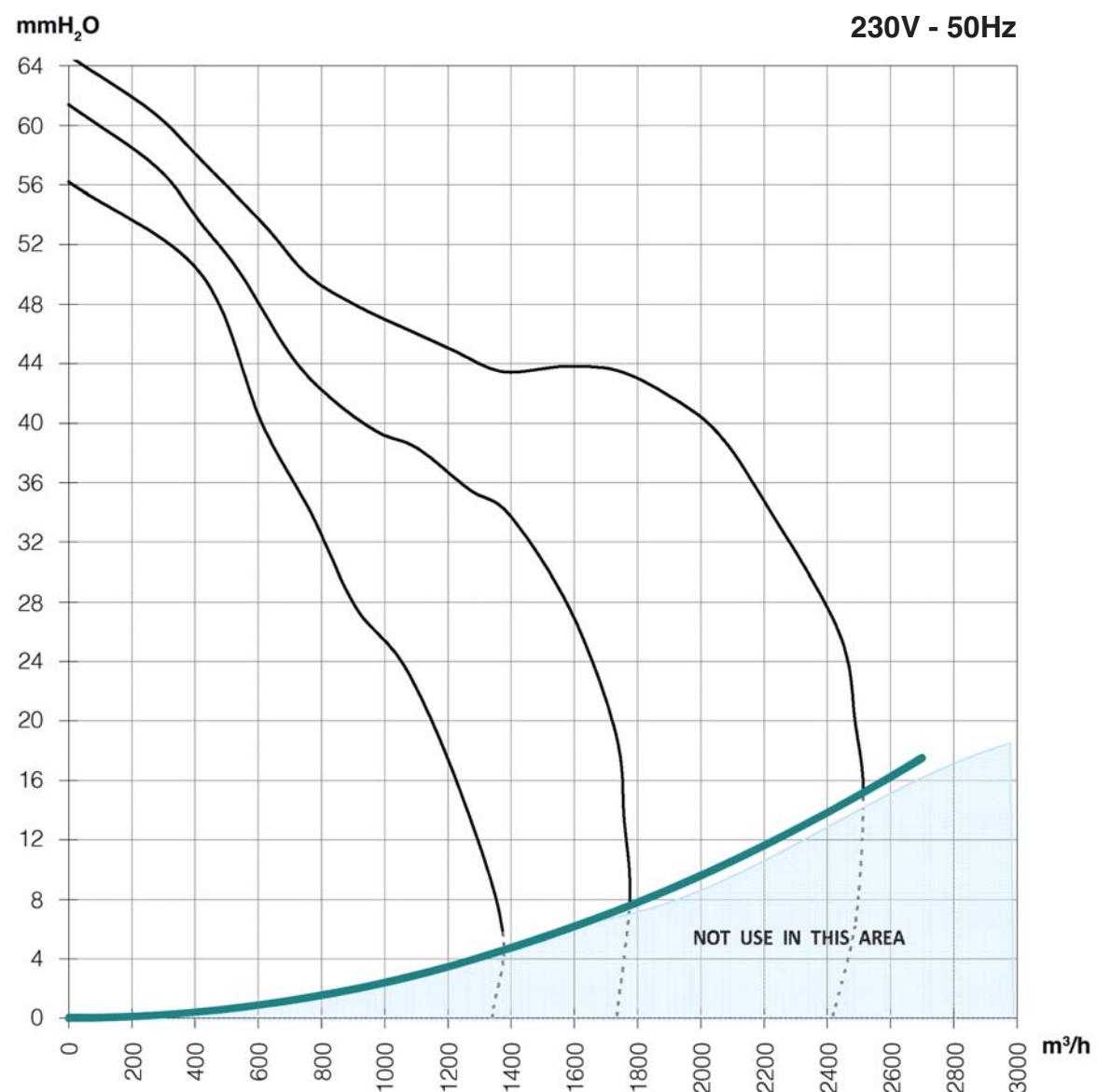
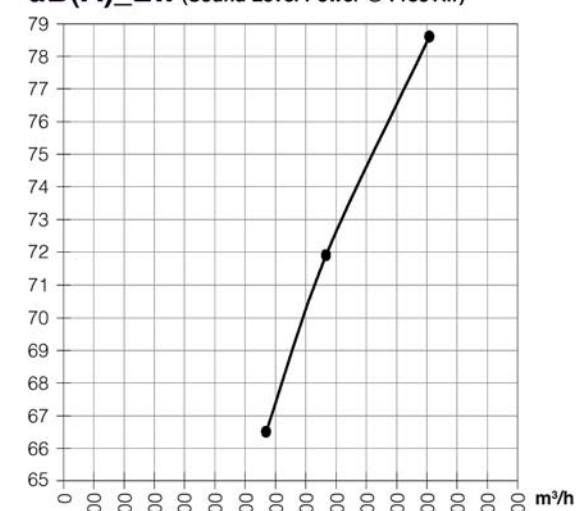



PERFORMANCE CURVES

DD 10/8 - 550-4P-3V 4 Poles

ErP 2015

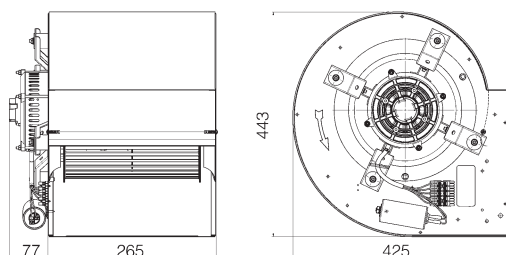

Ventilator Type: DD 10/8
 Blowers Material: Metal
 Housing Material: Metal
 Motor Support Material: Metal

Motor Type: 3 HOM
 Power Supply: 1 ~
 Nominal Voltage: 230V
 Frequency: 50-60 Hz
 Nominal Watts: 550
 Range Power: 200-254 V
 Capacitor: 12.5 µF

Electrical Insulation Class: Cl.F (155°C)
 Protection: Thermally Prot.

Test: PDD-5037 Web: 359

Operating limits Max Speed 50 Hz (Rating Values)

Win: Max 1500 (W)
 Ampere: Max 6.5 (A)
 Static Pressure: Min 10 - Max 56 (mmH₂O)

Measurement Category - A - Free Inlet - Free Outlet

Value @ max. efficiency (Max Speed 50 Hz)

Air Flow: 2140 (m³/h)
 Static Pressure: 47.7 (mmH₂O)
 Rpm: 1363 (min⁻¹)
 Power Input: 645 (W)

Overall efficiency (η): 43.2
 Grade efficiency (G): 50.7

dB(A)_LW (Sound Level Power @ Free Air)

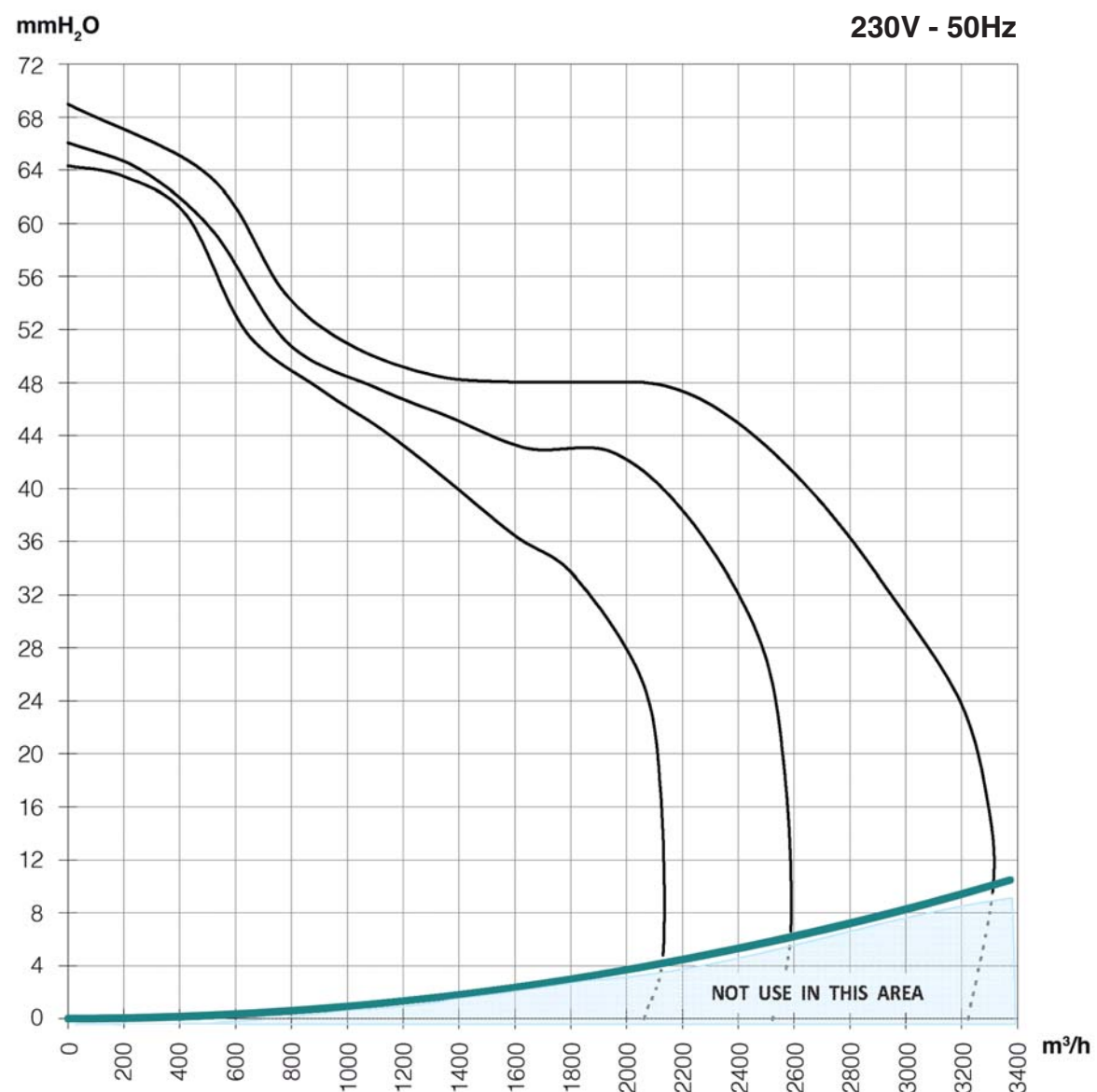
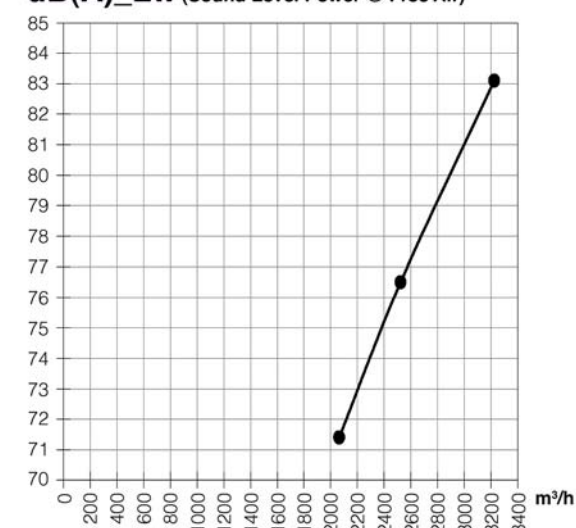

W in

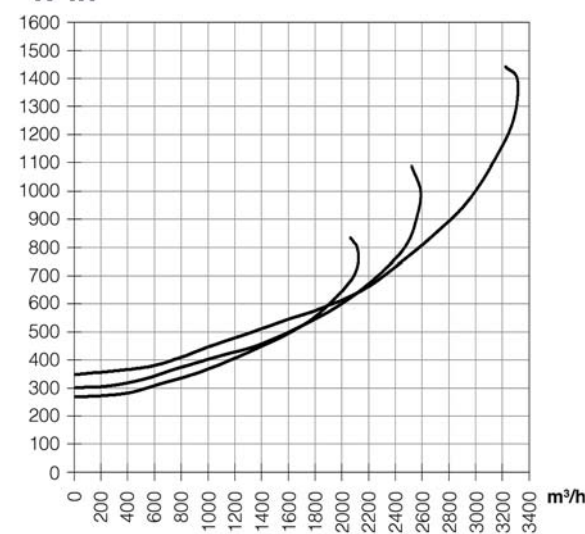

rpm

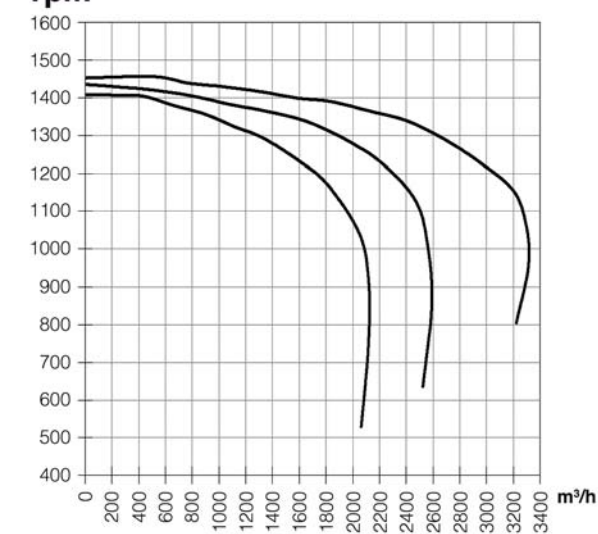

A

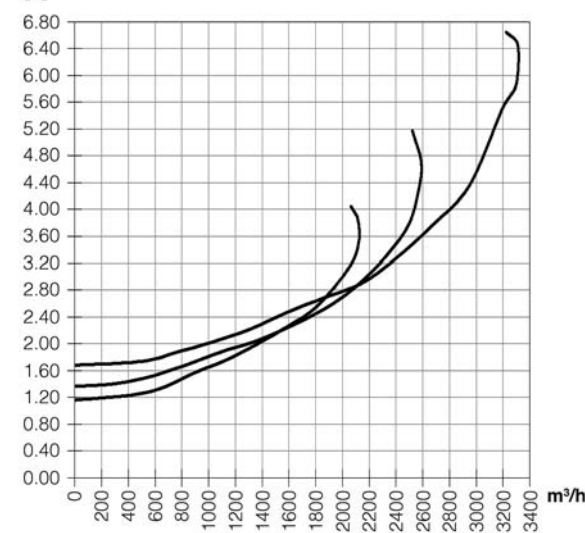

η static

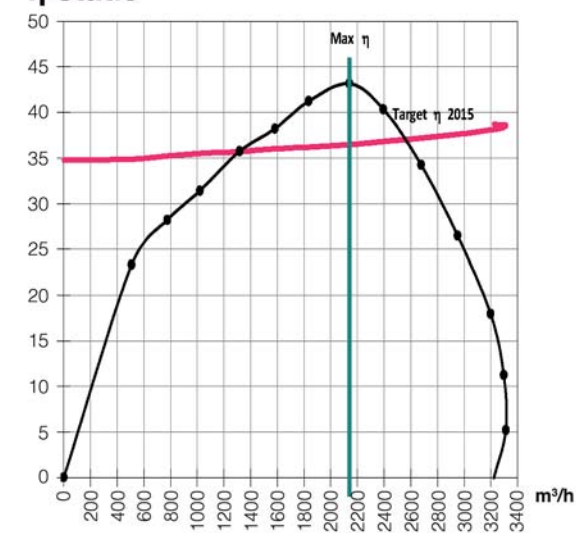



PERFORMANCE CURVES

DD 10/10 - 370-4P-3V 4 Poles

ErP 2015

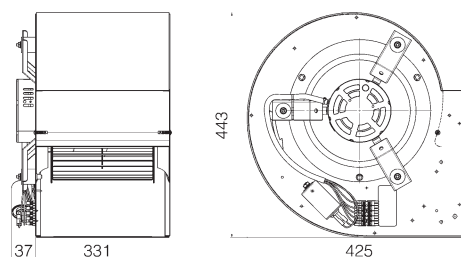

Ventilator Type: DD 10/10
 Blowers Material: Metal
 Housing Material: Metal
 Motor Support Material: Metal

Motor Type: 3 FGM
 Power Supply: 1 ~
 Nominal Voltage: 230V
 Frequency: 50-60 Hz
 Nominal Watts: 370
 Range Power: 200-254 V
 Capacitor: 12.5 µF

Electrical Insulation Class: Cl.F (155°C)
 Protection: Thermally Prot.

Test: PDD-5033 Web: 380

Operating limits Max Speed 50 Hz (Rating Values)

Win: Max 950 (W)
 Ampere: Max 4,3 (A)
 Static Pressure: Min 25 - Max 55 (mmH₂O)

Measurement Category - A - Free Inlet - Free Outlet

Value @ max. efficiency (Max Speed 50 Hz)

Air Flow: 1766 (m³/h)
 Static Pressure: 41.0 (mmH₂O)
 Rpm: 1243 (min⁻¹)
 Power Input: 547 (W)

Overall efficiency (η): 36.0
 Grade efficiency (G): 44.0

dB(A)_LW (Sound Level Power @ Free Air)

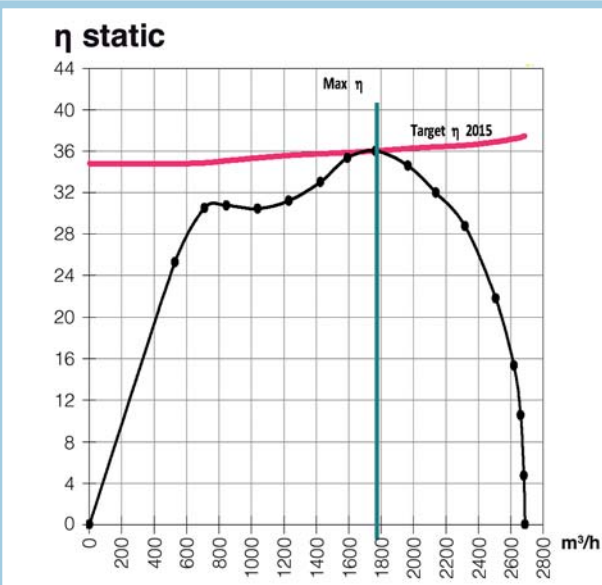
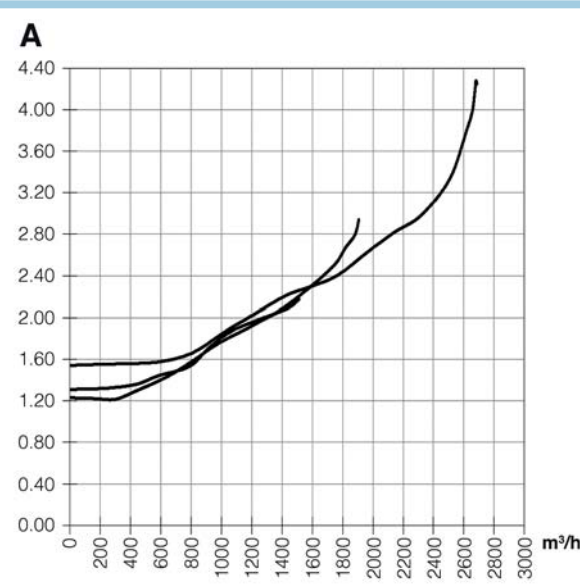
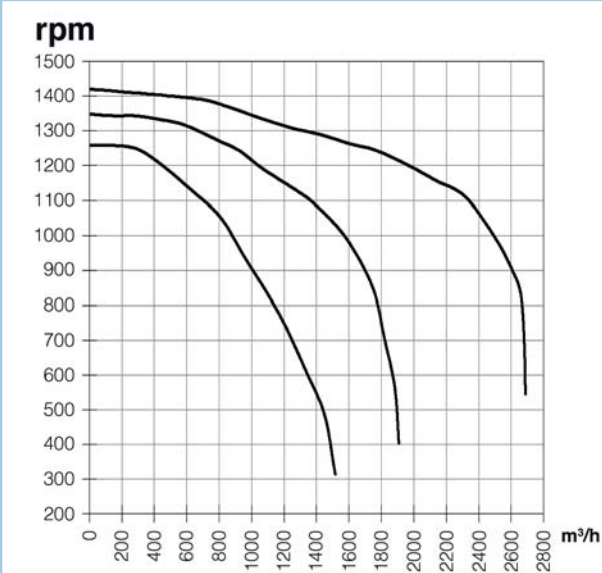
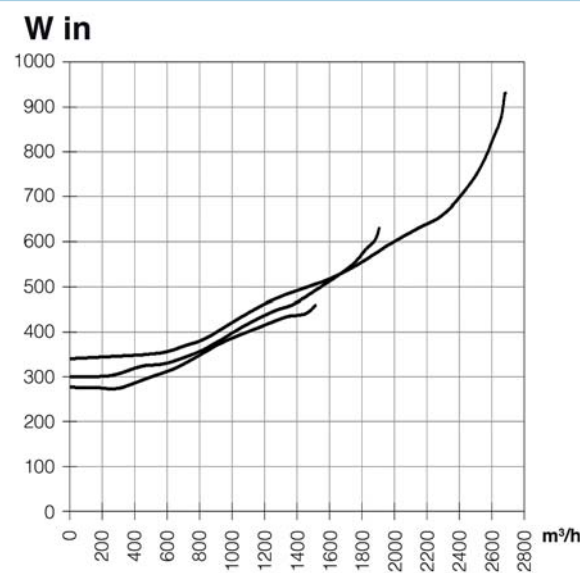
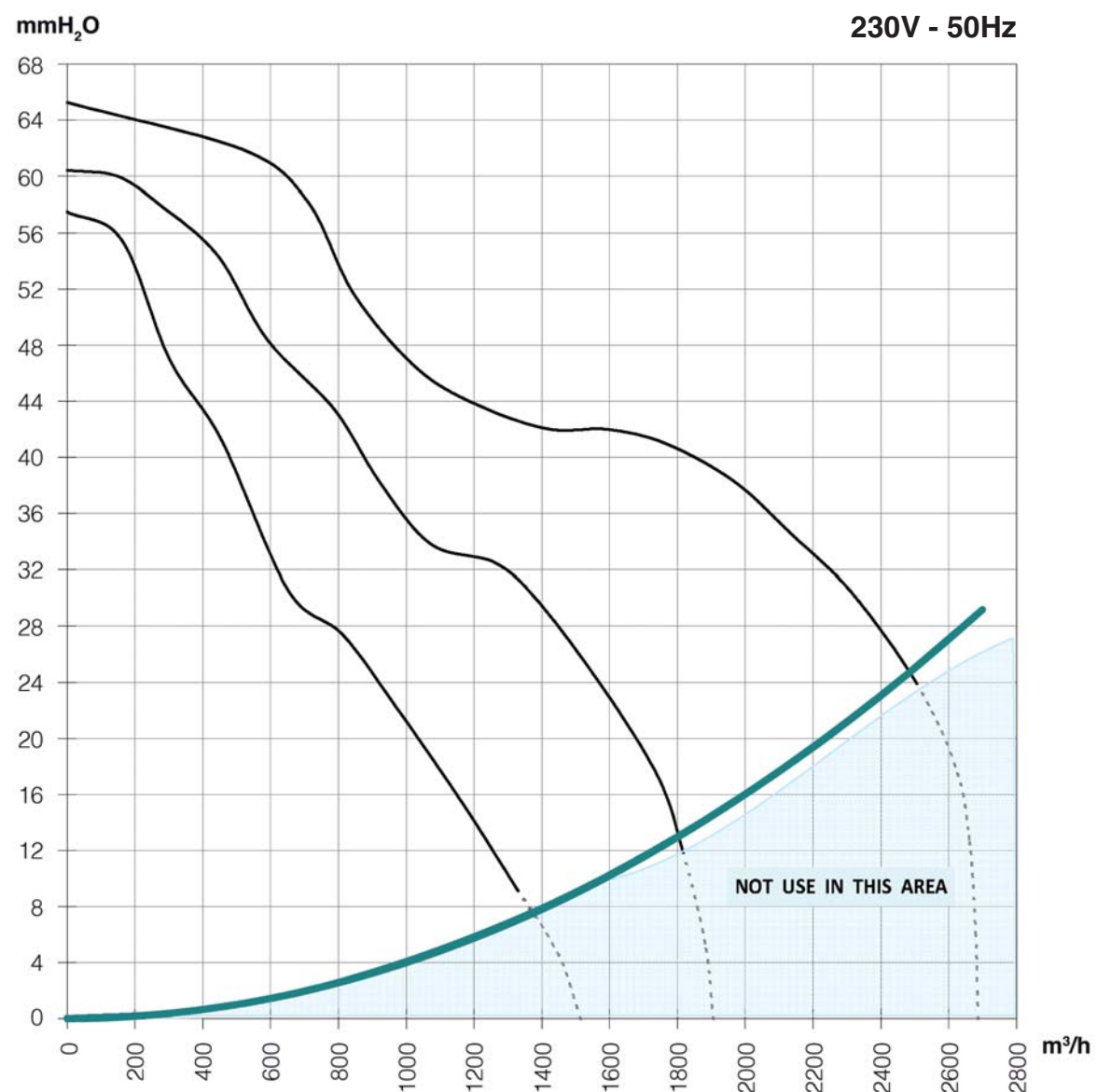
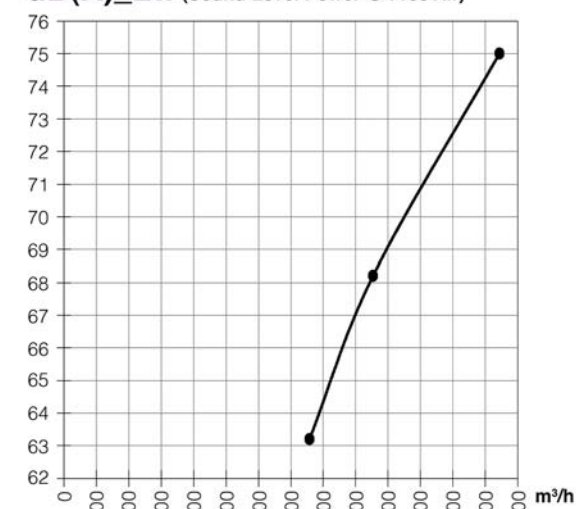



PERFORMANCE CURVES

DD 10/10 - 550-4P-3V 4 Poles

ErP 2015

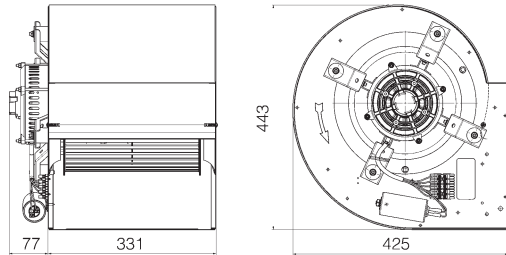

Ventilator Type: DD 10/10

Blowers Material: Metal
Housing Material: Metal
Motor Support Material: Metal

Motor Type: 3 HOM

Power Supply: 1 ~
Nominal Voltage: 230V
Frequency: 50-60 Hz
Nominal Watts: 550
Range Power: 200-254 V
Capacitor: 12.5 µF

Electrical Insulation Class: Cl.F (155°C)
Protection: Thermally Prot.

Test: PDD-5041 Web: 326

Operating limits Max Speed 50 Hz (Rating Values)

Win: Max 1400 (W)
Ampere: Max 6.4 (A)
Static Pressure: Min 15 - Max 60 (mmH₂O)

Measurement Category - A - Free Inlet - Free Outlet

Value @ max. efficiency (Max Speed 50 Hz)

Air Flow: 1920 (m³/h)
Static Pressure: 45.0 (mmH₂O)
Rpm: 1361 (min⁻¹)
Power Input: 643 (W)

Overall efficiency (η): 36.6
Grade efficiency (G): 44.1

dB(A)_LW (Sound Level Power @ Free Air)

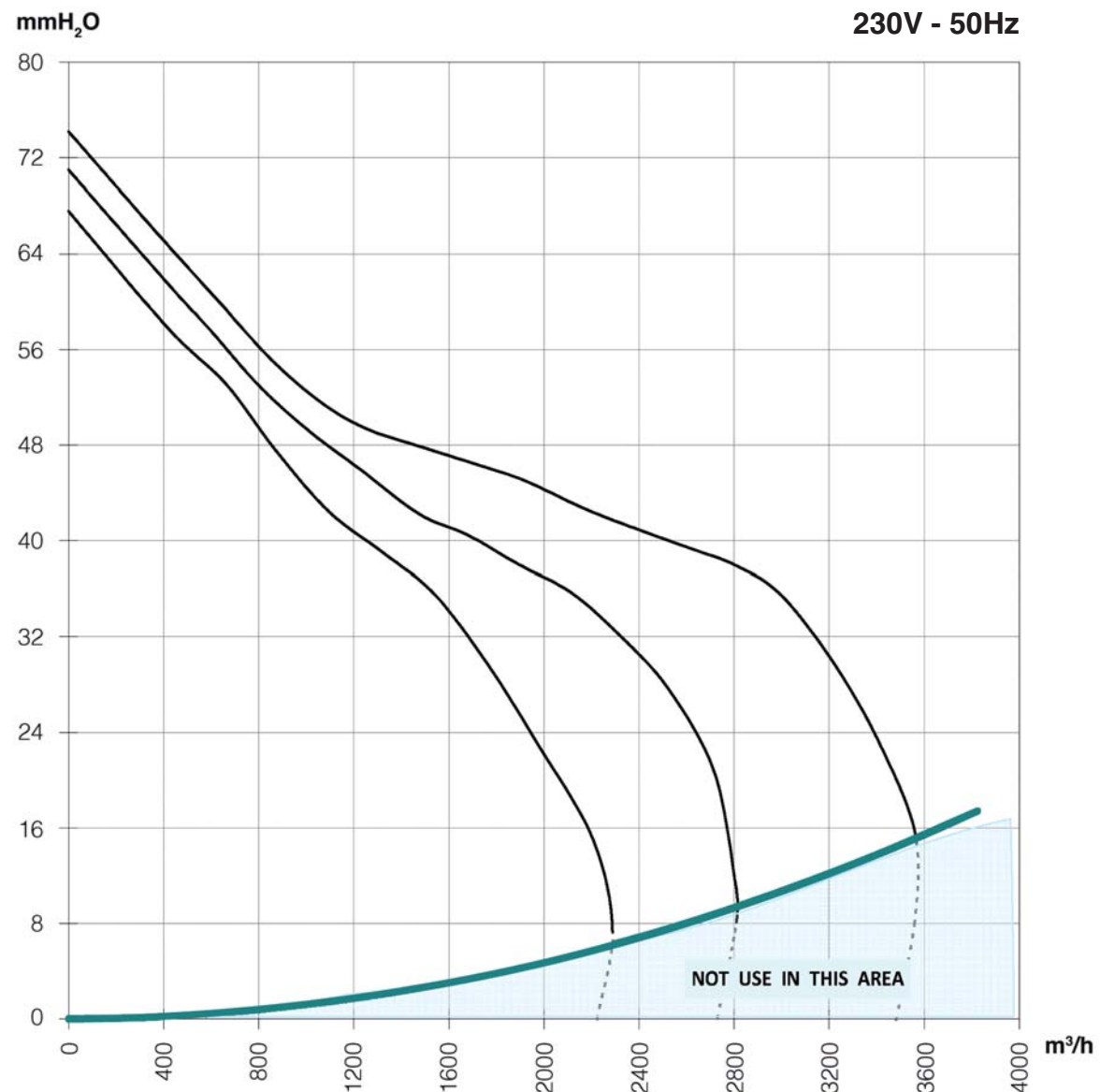
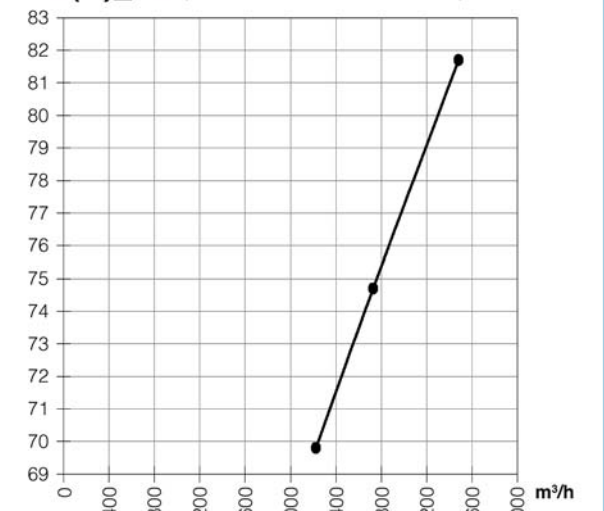

W in

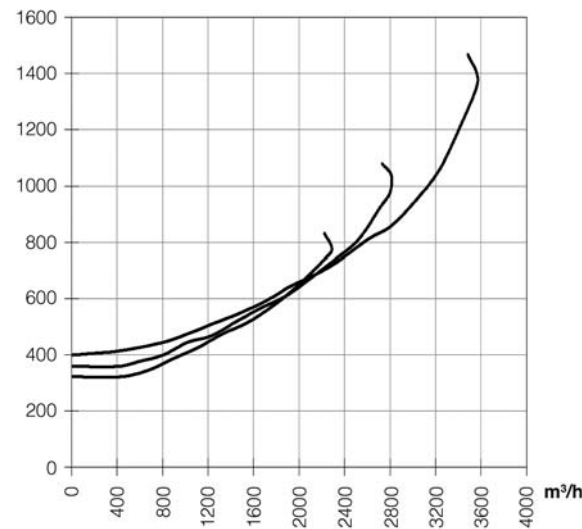

rpm

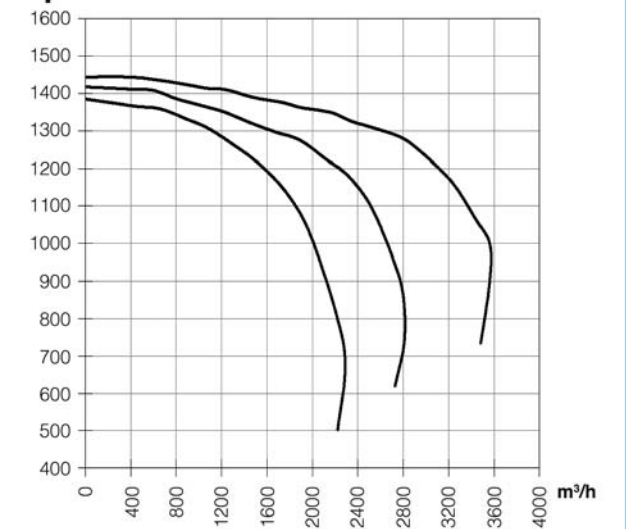

A

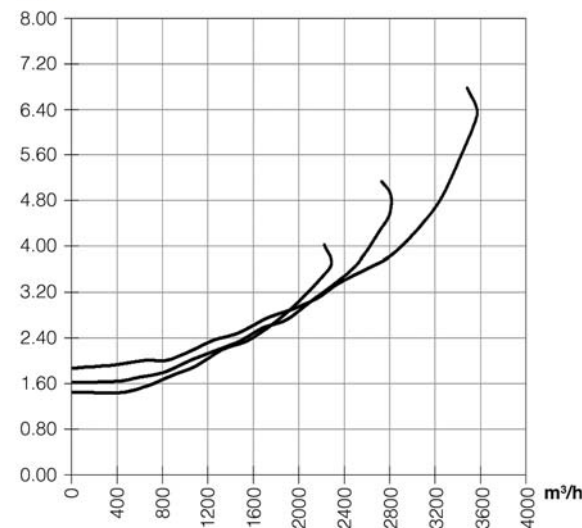

η static

